

TOSVERT VF-MB1/S15

**EtherNet/IP™ - Modbus® TCP option
Function Manual**

IPE002Z

NOTICE

1. Read this manual before installing or operating. Keep this instruction manual on hand of the end user, and make use of this manual in maintenance and inspection.
2. All information contained in this manual will be changed without notice. Please contact your Toshiba distributor to confirm the latest information.

Introduction

Thank you for purchasing the “EtherNet/IP™ - Modbus® TCP option (IPE002Z)” for TOSVERT VF-MB1/S15 inverter. Before using EtherNet/IP™ - Modbus® TCP module, carefully read this function manual in order to completely and correctly utilize its excellent performance.

This option needs the option adaptor to connect VF-S15 which type form is SBP009Z. Please match here and buy it when SBP009Z is not at hand yet.

After reading this function manual, please keep it handy for future reference.



For details of its general handling, see an instruction manual attached with the option unit.

- TOSVERT VF-MB1 Instruction Manual E6581697
- TOSVERT VF-S15 Instruction Manual E6581611
- TOSVERT VF-MB1/S15 communication option Precautions Manual E6581739
- TOSVERT VF-MB1 Communication Function Instruction Manual E6581726
- TOSVERT VF-S15 Communication Function Instruction Manual E6581913





EtherNet/IP™ is a trademark of ControlNet International, Ltd.

Modbus® TCP is a registered trademark of AEG Schneider Automation International S.A.S.

■ Handling in general

 Warning	
 Prohibited	▼ Do not connect or disconnect a network cable while the Inverter power is on. It may lead to electric shocks or fire.
 Mandatory	▼ See the instruction manual attached with the option unit for cautions the handling. Otherwise, it may lead to electric shocks, fire, injuries or damage to product.

■ Network control

 Warning	
 Prohibited	▼ Do not send the value out of the valid range to objects and attributes. Otherwise, the motor may suddenly start/stop and that may result in injuries.
 Mandatory	▼ Use an additional safety device with your system to prevent a serious accident due to the network malfunctions. Usage without an additional safety device may cause an accident.
 Caution	
 Mandatory	▼ Set up “Communication error trip function (see below)” to stop the Inverter when the option unit is deactivated by an unusual event such as tripping, an operating error, power outage, failure, etc. <ul style="list-style-type: none"> - Network Time-Out, Inverter operation at disconnection, Preset speed operation selection (Refer to "3.2.3 Network error detection (C 100 - C 103 . C 523)" for details) Deactivated the option module may cause an accident, if the “Communication error trip function” is not properly set up.
	▼ Make sure that the operation signals are STOP before resetting Inverter’s fault. The motor may suddenly start and that may result in injuries.

■ Notes on operation

Notes	
	▼ When the control power is shut off by the instantaneous power failure, communication will be unavailable for a while.
	▼ The Life of EEPROM is approximately 100,000 times. Avoid writing a command more than 100,000 times to the same parameter of the Inverter and the option module.

Table of Contents

1. OVERVIEW	4
2. NAMES AND FUNCTIONS	4
2.1. Outline	4
2.2. RJ45 connector pin layout	5
2.3. Example of connection to an EtherNet/IP™ and Modbus® TCP	5
2.4. LED indicator	6
3. PARAMETERS	7
3.1. Communication parameters	7
3.2. The details of the parameter setting	11
3.2.1. Device name (C001-C096)	11
3.2.2. Assigning IP addresses (C504, C505-C516)	12
3.2.3. Network error detection (C100-C103, C523)	13
3.2.4. Command data (C001-C006), Monitor data (C021-C026)	14
4. OBJECTS	22
4.1. Identity Object (0x01)	23
4.2. Message Router Object (0x02)	25
4.3. Assembly Object (0x04)	26
4.4. Connection Manager Object (0x06)	27
4.5. Motor Data Object (0x28)	28
4.6. Control Supervisor Object (0x29)	29
4.6.1. Run/Stop Event Matrix	31
4.6.2. State of the drive	31
4.6.3. Control Supervisor State Transition Diagram	31
4.7. AC/DC Drive Object (0x2A)	32
4.8. Parameter Objects (0x64)	33
4.9. Parameter Objects (0x65)	35
4.10. Port Object (0xF4)	36
4.11. TCP/IP interface Object (0xF5)	37
4.12. Ethernet link object (0xF6)	40
5. CONFIGURATION OF THE ASSEMBLIES	44
5.1. List of Assembly Object Instance	44
5.1.1. Instance 20: CIP basic speed control output	45
5.1.2. Instance 70: CIP basic speed control input	45
5.1.3. Instance 21: CIP extended speed control output	46
5.1.4. Instance 71: CIP extended speed control input	46
5.1.5. Instance 100: Native drive output	47
5.1.6. Instance 150: Native drive input	47
5.1.7. Instance 101: Native drive output	49
5.1.8. Instance 151: Native drive input	49
5.1.9. Instance 102: Native drive output	51
5.1.10. Instance 152: Native drive input	51
5.1.11. Instance 105: TOSHIBA specific output	52
5.1.12. Instance 155: TOSHIBA specific input	52
6. ABOUT EDS FILE	54
7. INTEGRATION IN RSLOGIX™	54
7.1. Create a new project	54
7.2. Add a EtherNet/IP scanner to the I/O configuration	55
7.3. Configure the VF-MB1/S15 EtherNet/IP module	57
7.4. Download the program to the PLC	59
7.5. Edit the I/O scan data	61
8. MODBUS TCP SERVER	64
8.1. Modbus TCP frames	64
8.2. Drive Modbus servers	64
8.3. List of Modbus functions supported	64
8.4. "03 (0x03) Read Holding Registers" function	65
8.5. "06 (0x06) Write Single Register" function	66
8.6. "16 (0x10) Write Multiple Registers" function	67

8.7.	"23 (0x17) Read/Write Multiple Registers" function.....	68
8.8.	"43 (0x2B) Read Device identification" function	69
8.9.	Parameter data	71
9.	IO SCANNING SERVICE.....	72
9.1.	Presentation	72
9.2.	Periodic variables.....	72
10.	EXAMPLE OF THE SETUP WITH PL7™	73
10.1.	Defining the hardware configuration.....	73
10.2.	BOOTP configuration	74
10.3.	Configuring Modbus messaging.....	75
10.4.	Configuring periodic variables	76
11.	COMMAND & SETPOINT SELECTION (LOCAL/REMOTE).....	77
12.	UNUSUAL DIAGNOSIS	79
12.1.	Option error	79
12.2.	Disconnection error of network cable.....	79
13.	WEBSERVER.....	80
13.1.	Access to the webservice	80
13.2.	Web pages structure	81
13.3.	Drive monitor (Main menu: Monitoring).....	82
13.4.	Drive parameters (Main menu: Monitoring).....	83
13.5.	Network parameters (Main menu: Network Setup).....	85
13.6.	Modbus scanner (Main menu: Network Setup).....	85
13.7.	EthIP scanner (Main menu: Network Setup).....	86
13.8.	Administration (Main menu: Network Setup).....	87
13.9.	TCP/IP statistics (Main menu: Diagnostics).....	88

1. Overview

The EtherNet/IP™ - Modbus® TCP option (IPE002Z) allows the VF-MB1/S15 inverter to be connected into the EtherNet/IP™ - Modbus® TCP network.

2. Names and functions

The drawing below shows names and functions of main parts.

2.1. Outline

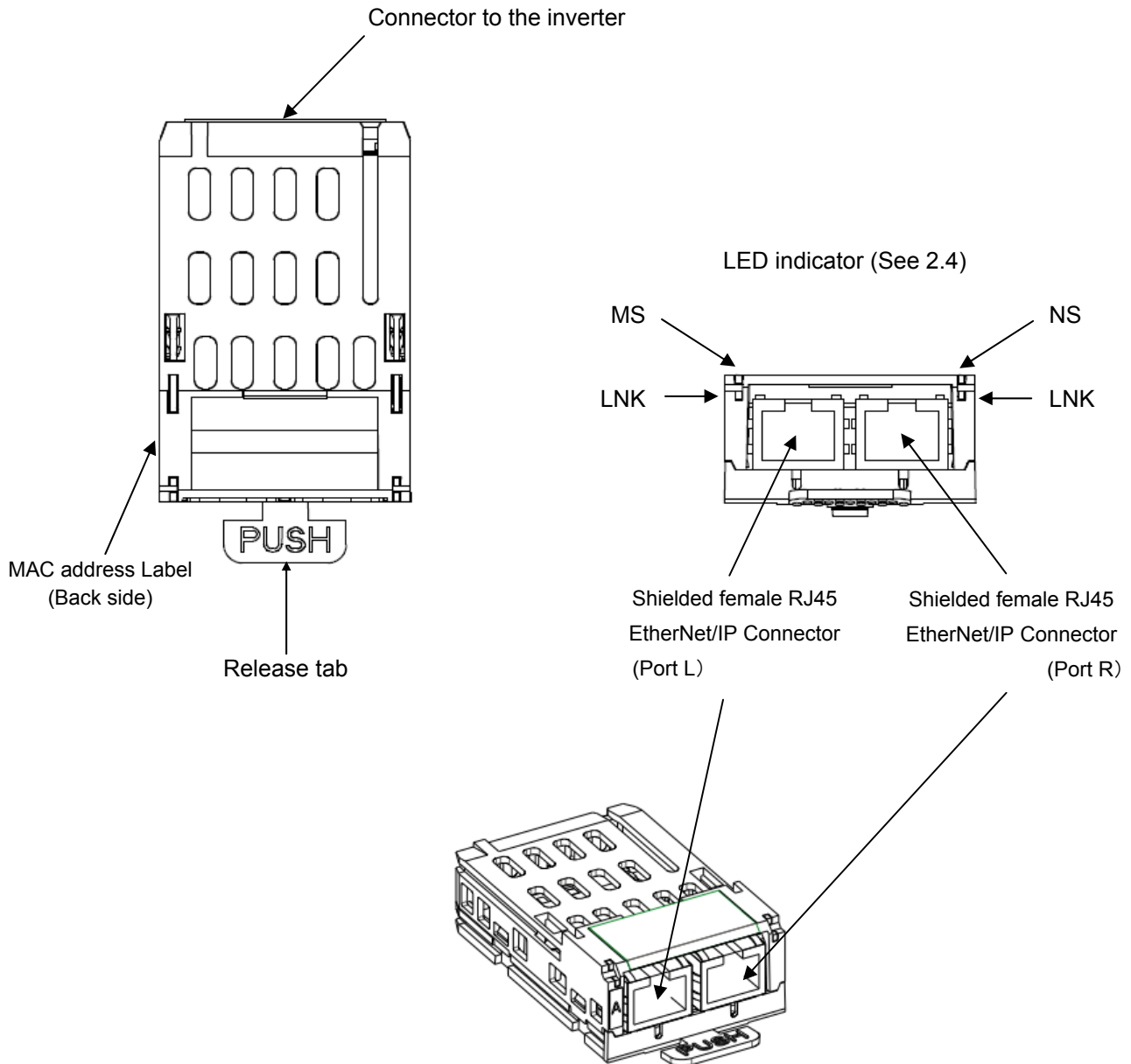

2.2. RJ45 connector pin layout

The EtherNet/IP™ - Modbus® TCP option is equipped with two shielded RJ45 connectors.

When you use VF-MB1, the shielding is connected to the drive ground. When you use VF-S15, the shielding is connected to the grounding terminal of option adapter.

Use an STP (shielded twisted pair) Ethernet cable.

The transmission speed is detected automatically by the unit (10 Mbps or 100 Mbps).

The card can operate in half duplex or full duplex mode, whether connected to a hub or a switch and regardless of the transmission speed (10 Mbps or 100 Mbps).

Port L and Port R

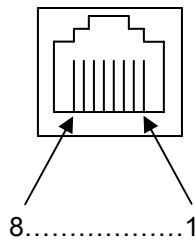

Pin	Signal
1	TD+
2	TD-
3	RD+
4	-
5	-
6	RD-
7	-
8	-

Note: Fix a cable so that a communication connector may be not taken the weight of wire.

2.3. Example of connection to an EtherNet/IP™ and Modbus® TCP

Example of daisy chain topology and star topology

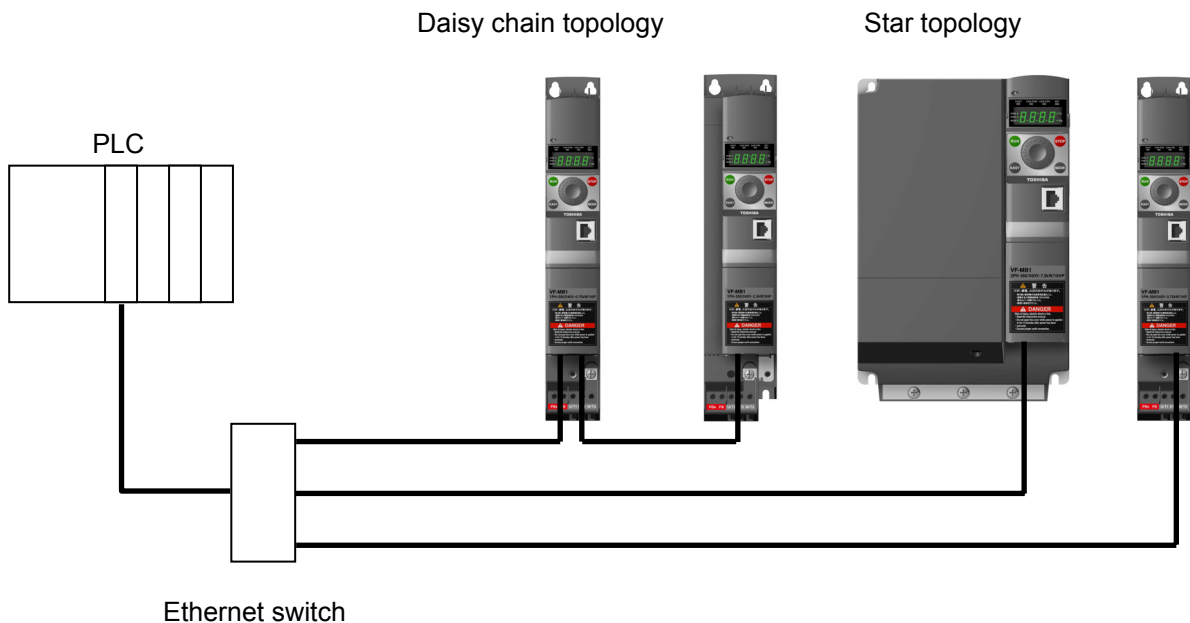

2.4. LED indicator

The LED shows the present status of the network and module.

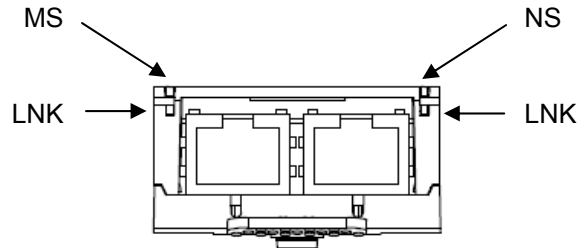

■The behavior of LNK LED

Link Activity		
Protocol	Color and behavior	Meaning
EtherNet/IP & Modbus TCP	OFF	No link
	Flashing Green/Red	Power up testing
	Green ON	Link at 100Mbps
	Yellow ON	Link at 10Mbps
	Green Blink	Activity at 100Mbps
	Yellow Blink	Activity at 10Mbps

■The behavior of MS LED

Module Status		
Protocol	Color and behavior	Meaning
EtherNet/IP	OFF	No power is supplied to the device
	Flashing Green/Red	Power up testing
	Green ON	The option is operating correctly
	Green flashing	The option has not been configured
	Red flashing	The option has detected a recoverable minor fault
	Red on	The option has detected a non-recoverable major fault
Modbus TCP	OFF	The option does not have an IP address or powered off
	Flashing Green/Red	Power up testing
	Green ON	The option is ready
	Green flashing	The option is not ready (waiting for cable connection or etc.)
	Red flashing	The option has detected a communication error (<i>E r r B</i>)
	Red ON	The option has detected a option module error (<i>E - 2 3</i>)

■The behavior of NS LED

Network Status		
Protocol	Color and behavior	Meaning
EtherNet/IP	OFF	The option does not have IP address or powered off
	Flashing Green/Red	Power up testing
	Green ON	The option has at least one established connection
	Green flashing	The option does not have at least one established connection
	Red flashing	One or more of the connections in which this device is the target has time out. This shall be left only if all time out connections are re-established or if the device is reset
	Red on	Error: duplicate IP address
Modbus TCP	OFF	The option does not have an IP address or powered off
	Flashing Green/Red	Power up testing
	Green ON	At least one port is connected and an IP address has been obtained
	Green flashing 3 times	All ports are unplugged, but the card has an IP address
	Green flashing 4 times	Error: duplicate IP address
	Green flashing 5 times	The card is performing a BOOTP or DHCP sequence

3. Parameters

3.1. Communication parameters

Set up the inverter parameters as follows. It is necessary to reset the inverter to update the parameter. This option doesn't operate if these parameters are not correctly set.

Title	Communication No.	Function	Description	Factory setting
<i>C00d</i>	0003	Command mode selection	0: Terminal board 1: Panel keypad (including remote keypad) 2: RS485 communication 3: CANopen communication 4: Communication option	1
<i>F00d</i>	0004	Frequency setting mode selection 1	0: Setting dial 1 (save even if power is off) 1: Terminal board VIA 2: Terminal board VIB 3: Setting dial 2 (press in center to save) 4: RS485 communication 5: UP/DOWN from external logic input 6: CANopen communication 7: Communication option 8: Terminal board VIC 9, 10: - 11: Pulse train input 12, 13: - * 14: <i>Sr0</i> *	0
<i>F856</i>	0856	Number of motor pole pair for communication	1: 2 poles 2: 4 poles 3: 6 poles 4: 8 poles 5: 10 poles 6: 12 poles 7: 14 poles 8: 16 poles	2
<i>F899</i>	0899	Communication function reset	0: - 1: Reset (after execution: 0)	0

* There selections are effective in only VF-S15.

Title	Communication No.	Function	Description	Factory setting
<i>C001</i>	C001	Scanner input 1 address ***	0: - 1: <i>F006</i> (Communication command 1) 2: <i>F023</i> (Communication command 2) 3: <i>F007</i> (Frequency command, 0.01Hz) 5: <i>F050</i> (Terminal output data) 6: <i>F051</i> (FM analog output) 8: <i>F601</i> (Stall prevention level, %) 13: <i>ACC</i> (Acceleration time 1, 0.1s) ** 14: <i>DEC</i> (Deceleration time 1, 0.1s) ** 15: <i>UL</i> (Upper limit, 0.01Hz) 16: <i>ub</i> (Torque boost value 1, 0.1%) 17: <i>uLw</i> (Base frequency voltage 1, 0.1V)	1
<i>C002</i>	C002	Scanner input 2 address ***	0-17 (Same as <i>C001</i>)	3
<i>C003</i>	C003	Scanner input 3 address ***	0-17 (Same as <i>C001</i>)	0
<i>C004</i>	C004	Scanner input 4 address ***	0-17 (Same as <i>C001</i>)	0
<i>C005</i>	C005	Scanner input 5 address ***	0-17 (Same as <i>C001</i>)	0
<i>C006</i>	C006	Scanner input 6 address ***	0-17 (Same as <i>C001</i>)	0

** : The unit depends on the *F519* setting.

*** : This parameter is effective by reset. Please reset (power supply reset or *F899=1*) after changing a set point.

Title	Communication No.	Function	Description	Factory setting
<i>C021</i>	C021	Scanner output 1 address ***	0: - 1: <i>Fd01</i> (Status information 1) 2: <i>Fd00</i> (Output frequency, 0.01Hz) 3: <i>Fd03</i> (Output current, 0.01%) 4: <i>Fd05</i> (Output voltage, 0.01%) 5: <i>Fc91</i> (Alarm information) 6: <i>Fd22</i> (PID feedback value, 0.01Hz) 7: <i>Fd06</i> (Input terminal board status) 8: <i>Fd07</i> (Output terminal status) 9: <i>FE36</i> (VIB input, 0.01%) 10: <i>FE35</i> (VIA input, 0.01%) 11: <i>FE37</i> (VIC input, 0.01%) 12: <i>Fd04</i> (Input voltage (DC detection), 0.01%) 13: <i>Fd16</i> (Estimated speed 0.01Hz) 14: <i>Fd18</i> (Torque, 0.01%) 15: - 16: - 17: - 18: - 19: <i>F880</i> (Free notes) 20: <i>Fd29</i> (Input power, 0.01kW) 21: <i>Fd30</i> (Output power, 0.01kW) 22: <i>FE14</i> (Cumulative operation time, hour) 23: <i>FE40</i> (FM terminal output monitor, 0.01%) 24: - 25: <i>Fd20</i> (Torque current, 0.01%) 26: <i>Fd23</i> (Motor overload factor, 0.01%) 27: <i>Fd24</i> (Drive overload factor, 0.01%) 28: <i>Fd25</i> (PBR overload factor, %) 29: <i>Fd26</i> (Motor load factor, %) 30: <i>Fd27</i> (Drive load factor, %) 31: <i>FE56</i> (Pulse train input, pps) 32: <i>FE70</i> (Drive rated current, 0.1A) 33: <i>FE76</i> (Input Watt-hour, 0.1kWh × 10 ^{F749}) 34: <i>FE77</i> (Output Watt-hour, 0.1kWh × 10 ^{F749}) 35: <i>Fd83</i> (IGBT temperature, degree C)	1
<i>C022</i>	C022	Scanner output 2 address ***	0-35 (Same as <i>C021</i>)	2
<i>C023</i>	C023	Scanner output 3 address ***	0-35 (Same as <i>C021</i>)	0
<i>C024</i>	C024	Scanner output 4 address ***	0-35 (Same as <i>C021</i>)	0
<i>C025</i>	C025	Scanner output 5 address ***	0-35 (Same as <i>C021</i>)	0
<i>C026</i>	C026	Scanner output 6 address ***	0-35 (Same as <i>C021</i>)	0
<i>C081-C096</i>	C081-C096	Device Name 1-16 ****	16 characters The device name is required if the card uses DHCP to obtain its IP Address. Refer to "3.2.1 Device name (c081-c096) for the details.	0,0,0,0,0,0,0,0
<i>C100</i>	C100	Communication error detection delay time	0.0 - 100.0 sec.	0.0
<i>C101</i>	C101	Inverter operation at the communication loss action	0: Stop and controlled by <i>Cn0d, Fndd</i> 1: Operation continue 2: Deceleration stop 3: Coast stop 4: Network error stop (<i>Er r B</i> trip) 5: Preset speed operation (by <i>C102</i> setting)	4
<i>C102</i>	C102	Preset speed operation selection	0: None 1 to 15: Preset speed	0
<i>C103</i>	C103	Communication time-out condition selection	0: Disconnection detection 1: When communication mode enable (Both <i>Cn0d</i> and <i>Fndd</i> are set CANopen or communication option) only 2: 1 + Driving operation	0

***: This parameter is effective by reset. Please reset (power supply reset or *F899=1*) after changing a set point.
 ****: (*EP*) does not work for this parameter.

Title	Communication No.	Function	Description	Factory setting
<i>C500</i>	C500	Protocol ***	This parameter is used to set the protocol of the option card. 0: Modbus TCP (default) 1: EtherNet/IP	0
<i>C501</i>	C501	Rate Setting ***	This field is used to set the transmission speed and the transmission mode of the card. 0: Autodetect(default) 1: 10Mbps Full 2: 10Mbps Half 3: 100Mbps Full 4: 100Mbps Half	0
<i>C502</i>	C502	Actual Rate (L port)	This field displays the baud rate and the transmission mode currently used by the communication card. (Display only) 0: unconnected 1: 10Mbps Full 2: 10Mbps Half 3: 100Mbps Full 4: 100Mbps Half	-
<i>C503</i>	C503	Actual Rate (R port)		
<i>C504</i>	C504	IP mode ***	Use this parameter to select the IP address assignment method. 0: Manual 1: BOOTP 2: DHCP Refer to "3.2.2 Assigning IP addresses" for the details.	0
<i>C505 - C508</i>	C505- C508	IP address ***	The IP address of the option module. These fields are effective settings at <i>C504</i> = 0. Refer to "3.2.2 Assigning IP addresses" for the details.	0.0.0.0
<i>C509 - C512</i>	C509- C512	Subnet Mask ***	The subnet mask of the option module. These fields are effective settings at <i>C504</i> = 0. Refer to "3.2.2 Assigning IP addresses" for the details.	0.0.0.0
<i>C513 - C516</i>	C513- C516	IP Gate ***	The gateway IP address of the option module. These fields are effective settings at <i>C504</i> = 0. Refer to "3.2.2 Assigning IP addresses" for the details.	0.0.0.0
<i>C517 - C522</i>	C517- C522	MAC address *****	The MAC address of the option module. [C517 - C518 - C519 - C520 - C521 - C522]	----
<i>C523</i>	C523	Time out	The waiting time from the occurrence of the network error to detection can be adjusted. * When you are using unconnected communication of the EtherNet/IP protocol, time out is not detected. 0.0: Disable 0.5 - 60 sec.	2
<i>C524 - C527</i>	C524- C527	IP address actual	The current IP address of the option module. Refer to "3.2.2 Assigning IP addresses" for the details.	-
<i>C528 - C531</i>	C528- C531	IP Mask actual	The subnet mask actual of the option module. Refer to "3.2.2 Assigning IP addresses" for the details.	-
<i>C532 - C535</i>	C532- C535	IP Gate actual	The gateway IP address actual of the option module. Refer to "3.2.2 Assigning IP addresses" for the details.	-

***: This parameter is effective by reset. Please reset (power supply reset or *F899* = 1) after changing a set point.

*****: .These values are displayed by decimal number format on panel of VFMB1/S15.



EtherNet/IP parameters

Title	Communication No.	Function	Description	Factory setting
<i>Ⓒ536</i>	C536	EtherNet Error	Monitor of the EtherNet error. 0: No error/clear error 1: Modbus TCP IO Scanning timeout 2: Network overload 3: Loss of Ethernet carrier	-
<i>Ⓒ554</i>	C554	Web service ***	Enables web server. 0: Disable 1: Enable	1
<i>Ⓒ555</i>	C555	Drive Status	Monitor the inverter status. 3: Gate Block 4: Run 23: Fault	-

Modbus TCP parameters

Title	Communication No.	Function	Description	Factory setting
<i>Ⓒ600-Ⓒ603</i>	C600-C603	IP Master ***	The IP address for PLC(Master) of the Modbus TCP.	0.0.0.0
<i>Ⓒ604</i>	C604	IO Scan active ***	Enables IO Scan function. 0: Non-active 1: Active	0

***: This parameter is effective by reset. Please reset (power supply reset or *F899=!*) after changing a set point.

 Warning	
 Mandatory action	<ul style="list-style-type: none"> ▼ Set up “Communication error trip function (<i>Ⓒ100</i> to <i>Ⓒ103</i> and <i>Ⓒ523</i>)” to stop the inverter when EtherNet/IP™ - Modbus® TCP communication is deactivated. ▼ When the parameters are changed, please reset (power supply reset or <i>F899=!</i>) the inverter for the changes to take effect.

3.2. The details of the parameter setting

3.2.1. Device name (C081-C096)

This option module can set the "Device name" of 16 characters.

(Device name (C081-C096) is 1 character within one parameter.)

The device name is required if the option module uses DHCP to obtain its IP Address.

Please set the setting of the device name according to the following rules.

1. The parameter is displayed by the hexadecimal number.
2. One parameter shows an ASCII character.
3. The relation between the device name and the parameter is as follows.

Example for Device Name ='VFMB1-4007PL'

Chars No.	Parameter	Character (Ex.)	ASCII (Ex.)
1	C081	'V'	56H
2	C082	'F'	46H
3	C083	'M'	4DH
4	C084	'B'	42H
5	C085	'1'	31H
6	C086	'-'	2DH
7	C087	'4'	34H
8	C088	'0'	30H
9	C089	'0'	30H
10	C090	'7'	37H
11	C091	'P'	50H
12	C092	'L'	4CH
13	C093	-	-
14	C094	-	-
15	C095	-	-
16	C096	-	-

3.2.2. Assigning IP addresses ($\text{C}504, \text{C}505 - \text{C}516$)

The drive needs 3 (4-Modbus TCP) IP addresses.

*The drive IP address.

*The subnet mask.

*The gateway IP address.

(*The IP Master address.- Modbus TCP protocol only)

These parameters are effective settings at $\text{C}504 = 0$ (IP mode: Manual).

If the address has been given by a BOOTP or a DHCP server, these parameters are invalidity.

- After dynamic addressing by a BOOTP or DHCP server, the new address value is displayed in the parameters. ($\text{C}524 - \text{C}535$)

They can be provided by:

*BOOTP server (correspondence between the MAC address and the IP addresses).

*DHCP server (correspondence between Device Name and the IP addresses).

The address is assigned according to the IP mode parameter.

$\text{C}504$: IP mode	Comments
0	The option uses the address defined in $\text{C}505 - \text{C}516$.
1	The option receives its address from a BOOTP server.
2	The option receives its address from a DHCP server. *Device name contains ($\text{C}081 - \text{C}096$) a valid name.

Note: The IP mode parameter may be modified according to the configuration control attribute of the TCP/IP interface object (CIP standard).

3.2.3. Network error detection (C 100 - C 103, C 523)

▼ Display of trip information

Err B (Optional unit fault 1: 1BH): Network error stop

▼ Related parameter

Title	Function	Setting range	Description
C 100	Communication error detection delay time	0.0-100.0 sec	<p>The waiting time from when a network error occurs can be adjusted. If a network error continues past the time set in C 100, it is recognized as a communication error and the operation of the inverter follows the setting of C 101.</p> <p>When normal communication returns during the setting time, a communication error is not displayed and operation is continued.</p> <p>*The case of Modbus[®] TCP protocol The time-out detection time provides by C 523 parameter. Disconnection detection time = C 523 (Time out) + C 100 (Communication error detection delay time)</p> <p>*The case of EtherNet/IP[™] protocol -At I/O scanning and connected communication Time-out time = $RPI \times 4 \times 2^{\text{Connection Timeout Multiplier}} [\mu\text{s}] + C 100$ (communication error detection delay time) [0.1s] RPI: Request Packet Interval</p> <p>-At Unconnected communication Time-out is not operating.</p>
C 101	Inverter operation at the communications loss action	0-5	The operation of the inverter when the communication fault occurs can be specified.
C 102	Preset speed operation selection	1-15	The operation frequency of the inverter when the communication fault occurs can be specified. (Only when C 101 is set to 5)
C 103	Communication time-out condition selection	0-2	Select the communication time-out condition.
C 523	Time out	0.0: Disable 0.5 - 60 sec.	<p>The waiting time from the occurrence of the network error to detection can be adjusted.</p> <p>* When you are using unconnected communication of the EtherNet/IP protocol, time-out is not detected.</p>

3.2.4. Command data (C001-C006), Monitor data (C021-C026)

The outline is indicated about the setting item of parameter C001 - C006 and C021 - C026 in Instance 102/152 and 105/155 of use. Please refer to a communication functional description for details.

3.2.4.1. How to use Instance 102/152 and 105/155

Instance 102/152 and 105/155 choose a command or the monitor of the driving state by a menu of C001 - C006 and C021 - C026 and can perform the communication that is cyclic of EtherNet/IP™ and Modbus® TCP (ID = 255).

Example 1: Command transmitting by output Instance 102

If the command value "C400" set to parameter FA06, Choose parameter FA06 (a communication option command) for command data (C001=1 (FA06)).

For example, please set C400 in FA06 when you want to send the command from an EtherNet/IP™ option and the availability of the frequency order and a driving order. (Please refer to "3.2.4.2")

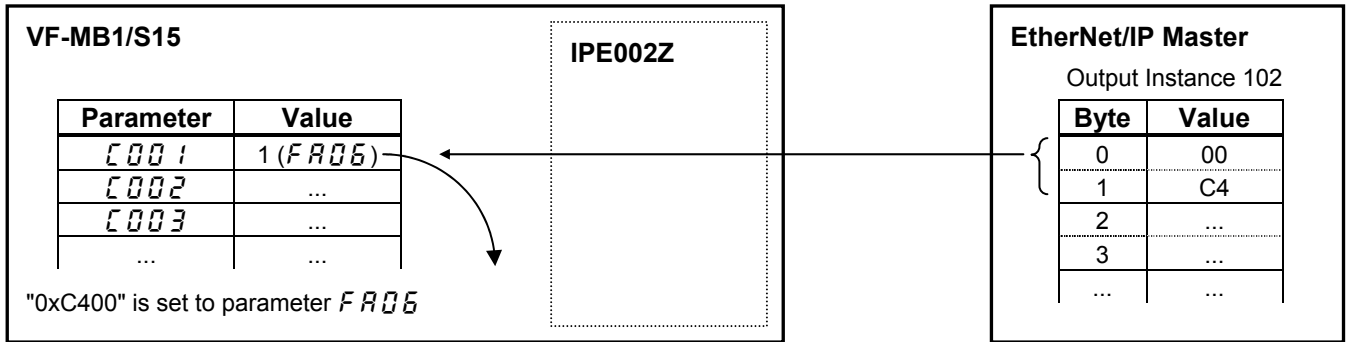

Example 2: State monitoring by the input instance 152.

When you want to monitor the output current, set "3 (Fd03)" to parameter C021.

The value of the parameter Fd03 specified as 0 and 1 byte of the input instance 152 with the parameter C021 is inputted.

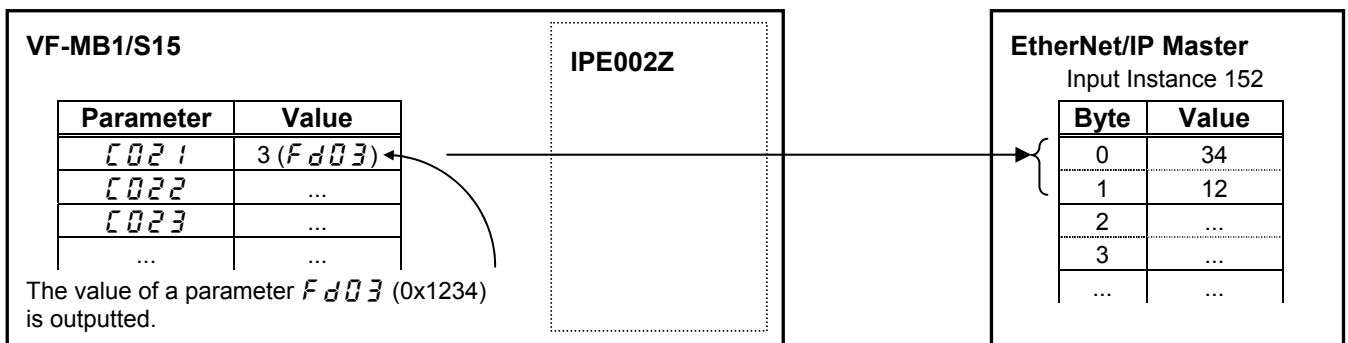

3.2.4.2. *FAD5* (Communication command1)

bit	Function	0	1	Note
0	Preset speed operation frequencies 1	0000: Preset speed operation OFF * 0001-1111: Setting of preset speed operation frequencies (1-15)		Preset speed operation is disabled or preset speed operation frequencies (1-15) are set by specifying bits for preset speed operation frequencies 1-4.
1	Preset speed operation frequencies 2			
2	Preset speed operation frequencies 3			
3	Preset speed operation frequencies 4			
4	Motor selection (1 or 2) (THR 2 selection)	Motor 1 (THR 1)	Motor 2 (THR 2)	THR 1: $Pt = \text{setting value}, tHr$ THR 2: $Pt = 0, F170, F171, F172, F173$
5	PI D control	Normal operation	PI D off	-
6	Acceleration/deceleration pattern selection (1 or 2) (AD2 selection)	Acceleration/deceleration pattern 1 (AD1)	Acceleration/deceleration pattern 2 (AD2)	AD1: ACC, dec AD2: $F500, F501$
7	DC braking	OFF	Forced DC braking	-
8	Jog run	OFF	Jog run	-
9	Forward/reverse run selection	Forward run	Reverse run	-
10	Run/stop	Stop	Run	-
11	Coast stop command	Standby	Coast stop	-
12	Emergency stop	OFF	Emergency stop	Always enable, "E" trip
13	Fault reset	OFF	Reset	No data is returned from the drive
14	Frequency priority selection	OFF	Enabled	Enabled regardless of the setting of $FADd$
15	Command priority selection	OFF	Enabled	Enabled regardless of the setting of $CADd$

*: When 14($SR0$) is set to $FADd$, preset speed operation frequency 0 is selected in using VFS15,.

3.2.4.3. *FA23* (Communication command 2)

bit	Function	0	1	Note
0	(Reserved)	-	-	-
1	Electric power quantity reset	OFF	Reset	Electric power quantity (<i>FE75</i> , <i>FE77</i>) reset
2	(Reserved)	-	-	-
3	(Reserved)	-	-	-
4	(Reserved)	-	-	-
5	(Reserved)	-	-	-
6	(Reserved)	-	-	-
7	Maximum deceleration forced stop	Normal	Enabled	-
8	Acceleration/deceleration selection 1	00: Acceleration/deceleration 1 01: Acceleration/deceleration 2 10: Acceleration/deceleration 3		Select acceleration/deceleration 1-3 by combination of two bits.. AD1: <i>ACC</i> , <i>DEC</i> AD2: <i>F500</i> , <i>F501</i> AD3: <i>F510</i> , <i>F511</i>
9	Acceleration/deceleration selection 2			
10	(Reserved)	-	-	-
11	(Reserved)	-	-	-
12	OC stall level switch	OC stall 1	OC stall 2	OC stall 1: <i>F601</i> OC stall 2: <i>F185</i>
13	(Reserved)	-	-	-
14	(Reserved)	-	-	-
15	(Reserved)	-	-	-

Note: Set 0 to reserved bit.

3.2.4.4. *F A 0 7* (frequency reference from internal option)

Frequency reference is set up by 0.01Hz unit and the hexadecimal number.
 For example, when "Frequency reference" is set up to 80Hz, since the minimum unit is 0.01Hz,
 $80 / 0.01 = 8000 = 0x1F40$ (Hex.)

3.2.4.5. *F A 5 0* (Terminal output data from communication)

The output data on the terminal board can be directly controlled with the computer.
 To use this function, select functions from 92 to 95 in advance for the output terminal selection parameters *F 130*, *F 131*, *F 132*. If bit 0 through bit1 of the data (*F A 5 0*) is set with the computer, the specified data (0 or 1) can be output to the selected output terminal.

Data composition of output data on the terminal board (*F A 5 0*)

bit	Output TB function name	0	1
0	Specified data output 1 (Output terminal No.: 92, 93)	OFF	ON
1	Specified data output 2 (Output terminal No.: 94, 95)	OFF	ON
2-15	(Reserved)	-	-

Note: Set 0 to reserved bit

Example of use: To control only the RY-RC terminal with the computer
 To turn on the RY terminal, set the output terminal selection 1A parameter (*F 130*) to 92 (Designated data output 1) and set 0001H to *F A 5 0*.

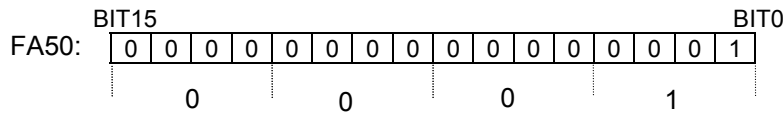

3.2.4.6. *F A 5 1* (Analog output (FM) data from communication)

Use this function, set the FM terminal meter selection parameter (*F A 5 L*) to 18 (communication data output).
 This makes it possible to send out the data specified as FM analog output data (*F A 5 1*) though the FM analog output terminal. Data can be adjusted in a range of 0 to 1000 (resolution of 10 bit).

Please refer to "Meter setting and adjustment" Section of the inverter's instruction manual.

3.2.4.7. *Fd01* (Inverter operating status 1)

bit	Function	0	1	Note
0	Failure FL	No output	Under in progress	-
1	Failure	Not tripped	Tripped	Trip status includes <i>trpy</i> and the trip retention status are also regarded as tripped statuses.
2	Alarm	No alarm	Alarm issued	-
3	Under voltage (<i>NOFF</i>)	Normal	Under voltage	-
4	Motor selection (1 or 2) (THR 2 selection)	Motor 1 (THR1)	Motor 2 (THR2)	THR1: <i>Pt</i> = setting value, <i>uL</i> , <i>uLu</i> , <i>ub</i> , <i>tHr</i> THR2: <i>Pt</i> = 0, <i>F170</i> , <i>F171</i> , <i>F172</i> , <i>F173</i>
5	PID control off	PID control permitted	PID control prohibits	-
6	Acceleration/deceleration pattern selection (1 or 2)	Acceleration/deceleration pattern 1 (AD1)	Acceleration/deceleration pattern 2 (AD2)	AD1: <i>ACC</i> , <i>DEC</i> AD2: <i>F500</i> , <i>F501</i>
7	DC braking	OFF	Forced DC braking	-
8	Jog run	OFF	Jog run	-
9	Forward / reverse run	Forward run	Reverse run	-
10	Run/stop	Stop	Run	-
11	Coast stop (ST = OFF)	ST=ON	ST=OFF	-
12	Emergency stop	No emergency stop status	Emergency stop status	-
13	Standby ST=ON	Start-up process	Standby	Standby: Initialization completed, not failure stop status, not alarm stop status (<i>NOFF</i> , <i>LL</i> forced stop), ST=ON, and RUN=ON
14	Standby	Start-up process	Standby	Standby: Initialization completed, not failure stop status and not alarm stop status (<i>NOFF</i> , <i>LL</i> forced stop)
15	(Reserved)	Undefined		-

Note: Don't use the reserved bit for the judgment.

3.2.4.8. *Fd00* (Output frequency)

The current output frequency is read into 0.01Hz of units and by the hexadecimal number. For example, when the output frequency is 80Hz, 0x1F40 (hexadecimal number) are read.

Since the minimum unit is 0.01%,
 $0x1F40 \text{ (Hex.)} = 8000 \text{ (Dec.)} \times 0.01 = 80 \text{ (Hz)}$

Also about the following parameters, these are the same as this.

- *Fd22* (Feedback value of PID)..... Unit: 0.01Hz
- *Fd16* (Estimated speed) Unit: 0.01Hz
- *Fd29* (Input power) Unit: 0.01kW
- *Fd30* (Output power) Unit: 0.01kW

3.2.4.9. *F d 0 3* (Output current)

The output current is read into 0.01% of units and by the hexadecimal number.

For example, when the output current of the rated current 4.8A drive is 50% (2.4A), 0x1388 (hexadecimal number) is read out.

Since the minimum unit is 0.01%,

$$0x1388 \text{ (Hex.)} = 5000 \text{ (Dec.)} \times 0.01 = 50 \text{ (\%)}$$

Also about the following parameters, these are the same as this.

- *F d 0 5* (Output voltage (real time))..... Unit: 0.01% (V)
- *F d 0 4* (Voltage at DC bus (real time))..... Unit: 0.01% (V)
- *F d 1 8* (Torque) Unit: 0.01% (Nm)*

* When the motor information connected to the drive set to the parameter (*F 4 0 5* - *F 4 1 5*), torque monitor value "100%" is same as the rated torque of a motor in general.

3.2.4.10. *F E 3 5, F E 3 6, F E 3 7* (Monitoring of the analog input VIA, VIB, VIC)

VIA terminal board monitor: "Communication Number *F E 3 5*"

VIB terminal board monitor: "Communication Number *F E 3 6*"

VIC terminal board monitor: "Communication Number *F E 3 7*"

These monitors can also be used as A/D converters irrespective of the drive's control.

VIA / VIC terminal board monitor is capable of reading the data from external devices in a range of 0.01 to 100.00% (unsigned data: 0x0000 to 0x2710).

VIB terminal board monitor is capable of reading the data from external devices in a range of -100.00 to 100.00% (signed data: 0xD8F0 to 0x2710).

If analog input mode is selected with the frequency setting mode selection parameter, however, keep in mind that any data entered via an analog terminal is regarded as a frequency command.

3.2.4.11. *F E 1 4* (Cumulative run time)

The operated cumulative time is read by the hexadecimal number.

For example, when cumulative operation time is 18 hours, 0x0012 (18 hours) is read.

$$0x0012 = 18 \text{ (Dec., hour)}$$

3.2.4.12. *F E 4 0* (Analog output (FM))

The output value of FM terminal is read.

The value range is set to 0 to 10000 (0x0000 to 2710H) which is corresponded to 0.00% to 100.00%.

For example, when analog output is 50.00%, 0x1388 is read.

$$0x1388 = 50.00 \text{ (Dec., \%)}$$

3.2.4.13. *F C 9* (Alarm code)

bit	Function	0	1	Remarks (Code displayed on the panel)
0	Over-current alarm	Normal	Alarming	<i>L</i> flicking
1	Inverter over load alarm	Normal	Alarming	<i>L</i> flicking
2	Motor over load alarm	Normal	Alarming	<i>L</i> flicking
3	Over heat alarm	Normal	Alarming	<i>H</i> flicking
4	Over voltage alarm	Normal	Alarming	<i>P</i> flicking
5	Main circuit undervoltage alarm	Normal	Alarming	-
6	main device overheat alarm	Normal	Alarming	<i>L</i> flicking
7	Under current alarm	Normal	Alarming	-
8	Over-torque alarm	Normal	Alarming	-
9	Braking resistor overload alarm	Normal	Alarming	-
10	Cumulative operation hours alarm	Normal	Alarming	-
11	Option communication alarm	Normal	Alarming	-
12	Serial communication alarm	Normal	Alarming	-
13	MOFFMS (MSrelay off or MOFF)	Normal	Alarming	-
14	Stop after instantaneous power off	-	Dec., Under stop	Refer to <i>F 3 0 2</i> value
15	Stop after LL continuance time	-	Dec., Under stop	Refer to <i>F 2 5 5</i> value

3.2.4.14. *F d 0 6* (Input TB Status)

bit	TB Name	Function (Parameter)	0	1
0	F	Input terminal function selection 1 (<i>F 1 1 1</i>)	OFF	ON
1	R	Input terminal function selection 2 (<i>F 1 1 2</i>)		
2	RES	Input terminal function selection 3 (<i>F 1 1 3</i>)		
3	S1	Input terminal function selection 4 (<i>F 1 1 4</i>)		
4	S2	Input terminal function selection 5 (<i>F 1 1 5</i>)		
5	S3	Input terminal function selection 6 (<i>F 1 1 6</i>)		
6	VIB *	Input terminal function selection 7 (<i>F 1 1 7</i>)		
7	VIA *	Input terminal function selection 8 (<i>F 1 1 8</i>)		
5 to 15	(Reserved)	-	Undefined	

Note: Don't use the reserved bit for the judgment.

* VIA/ VIB are input terminal function when *F 1 0 9* is logic input.

The input terminal function is selected by each parameter.

Example: Data set for FE06 when the F and RES terminals are ON = 0005H

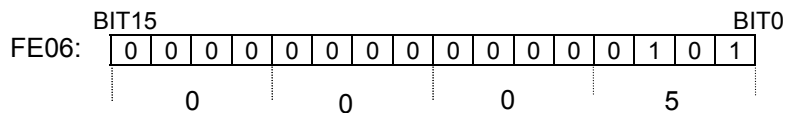

3.2.4.15. Fd07 (Output TB Status)

bit	TB Name	Function (Parameter)	0	1
0	RY-RC	Output terminal function selection 1A (F130)	OFF	ON
1	OUT	Output TB Function select 2A (F131)	OFF	ON
2	FL	Output TB Function select 3 (F132)	OFF	ON
3 - 15	(Reserved)	-	Undefined	

Note: Don't use the reserved bit for the judgment.

Example: Data set for FE07 when the RY and FL terminals are ON = 0005H

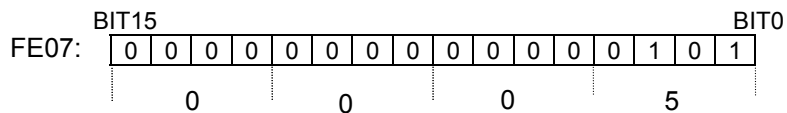

4. Objects

This section contains the object specifications for all EtherNet/IP objects currently supported by the "IPE002Z". Table 1 outlines those objects covered:

Class Code		Object Class	Page
Hex.	Dec.		
0x01	1	Identity Object	23
0x02	2	Message Router Object	25
0x04	4	Assembly Object	26
0x06	6	Connection Manager Object	27
0x28	40	Motor Data Object	28
0x29	41	Control Supervisor Object	29
0x2A	42	AC/DC Drive Object	32
0x64	100	Parameter Object	33
0x65	101	Parameter Object	35
0xF4	244	Port Object	36
0xF5	245	TCP/IP Interface Object	37
0xF6	246	Ethernet Link Object	39

Table 1: Supported Objects

For definitions of all data types referred to in these object specifications, refer to the ODVA EtherNet/IP™ Specifications. In general, however, the following are some of the most prevalent types:

BOOL	Boolean	0(False) or 1(TRUE)
SINT	Signed Short Integer	-128 to 127
INT	Integer	-32768 to 32767
DINT	Double Integer	-2^{31} to $2^{31}-1$
USINT	Unsigned Short Integer	0 to 255
UINT	Unsigned Integer	0 to 65535
UDINT	Unsigned Double Integer	0 to $2^{32}-1$
STRING	character string (1 byte per character)	
SHORT_STRING	character string (1 byte per character, 1 byte length indicator)	
BYTE	Bit string - 8-bits	
WORD	Bit string - 16-bits	
DWORD	Bit string - 32-bits	
EPATH	CIP path segments	

4.1. Identity Object (0x01)

Class code 0x01.

This object provides identification of and general information about the device.

Class Attributes

Instance	Attribute ID	Access	Name	Data type	Details	Value	
0	1	Get	Revision	UINT	Revision of this object	1	
	2	Get	Max Instances	UINT	Maximum instance number of an object currently created in this class level of the device.	1	
	3	Get	Number of Instances	UINT	Number of object instances currently created at this class level of the device.	1	
	4	Get	Optional attribute list	STRUCT of	List of optional instance attributes utilized in an object class implementation.	0	
				Number of attributes	UNIT	Number of attribute in the optional attribute list.	-
				Optional attributes	ARRAY of UNIT	List of optional attribute numbers.	-
	6	Get	Max ID of class attributes	UINT	The attribute ID number of the last class attribute of the class definition implemented in the device.	7	
7	Get	Max ID of instance attribute	UINT	The attribute ID number of the last instance attribute of the class definition implemented in the device.	7		

Class Service

Service Code	Service Name	Description of Service
0x01	Get_Attribute_All	Read all attributes
0x0E	Get_Attribute_Single	Read one attribute

Instance Attributes

Instance	Attribute ID	Access	Name	Data type	Details	Value	
1	1	Get	Vendor ID	UINT	Identification of vendor by number	377	
	2	Get	Device type	UINT	AC/DC Drive profile	2	
	3	Get	Product code	UINT	Identification No. of a drive		
				(case of VF-MB1)	32000		
				(case of VF-S15)	32001		
	4	Get	Revision	STRUCT of	Revision of the item the Identity Object represents		
				Major revision	USINT	Major revision of drive	1 *
				Minor revision	USINT	Minor revision of drive	8 *
	5	Get	Status	WORD	See "Attribute 5 State Description"	*	
	6	Get	Serial number	UDINT	4 last bytes of MAC Address	-	
7	Get	Product name	SHOT_STRING	Human readable identification			
				(case of VF-MB1 drive)	6, VF-MB1		
				(case of VF-S15 drive)	6, VF-S15		

* These values depend on firmware version and revision.

Instance Services

Service Code	Service Name	Description of Service
0x01	Get_Attribute_All	Read all attributes
0x05	Reset	Invokes the Reset for the device
0x0E	Get_Attribute_Single	Read one attribute

Attribute 5 State Descriptions

Adapted from document [CIP] "THE CIP NETWORKS LIBRARY"

Bit	Called	Definition
0	Owned	TRUE indicates the device (or an object within the device) has an owner. Within the Master/Slave paradigm the setting of this bit means that the Predefined Master/Slave Connection Set has been allocated to a master. Outside the Master/Slave paradigm the meaning of this bit is TBD. → unsupported
1	-	(System reserved)
2	Configured.	TRUE indicates the application of the device has been configured to do something different than the "out-of-box" default. This shall not include configuration of the communications.
3	-	(System reserved)
4-7	Extended Device Status	0000 Self-Testing or unknown
		0001 Firmware update in progress
		0010 At least one faulted I/O connection
		0011 No I/O connections established
		0100 Non-Volatile configuration bad
		0101 Major Fault – either bit 10 or bit 11 is true (1)
		0110 At least one I/O connection in run mode
		0111 At least one I/O connection established, all in idle mode
1000-1111	Unused	
8	Minor Recoverable Fault	TRUE indicates the device detected a problem with itself, which is thought to be recoverable. The problem does not cause the device to go into one of the faulted states.
9	Minor Unrecoverable Fault.	TRUE indicates the device detected a problem with itself, which is thought to be unrecoverable. The problem does not cause the device to go into one of the faulted states.
10	Major Recoverable Fault.	TRUE indicates the device detected a problem with itself, which caused the device to go into the "Major Recoverable Fault" state.
11	Major Unrecoverable Fault	TRUE indicates the device detected a problem with itself, which caused the device to go into the "Major Unrecoverable Fault" state.
12-15	-	(System reserved)

Note: Don't use the "System reserved" bit and Bit0 for the judgement.

4.2. Message Router Object (0x02)

Class code 0x02.

The Message Router Object provides a messaging connection point through which a Client may address a service to any object class or instance residing in the physical device.

Class Attributes

Instance	Attribute ID	Access	Name	Data type	Details	Value
0	1	Get	Revision	UINT	Revision of this object	1
	2	Get	Max Instances	UINT	Maximum instance number of an object currently created in this class level of the device.	1
	3	Get	Number of Instances	UINT	Number of object instances currently created at this class level of the device.	1
	4	Get	Optional attribute list	STRUCT of	List of optional instance attributes utilized in an object class implementation.	2
			Number of attributes	UNIT	Number of attribute in the optional attribute list.	2
			Optional attributes	ARRAY of UNIT	List of optional attribute numbers.	3
	6	Get	Max ID of class attributes	UINT	The attribute ID number of the last class attribute of the class definition implemented in the device.	7
7	Get	Max ID of instance attribute	UINT	The attribute ID number of the last instance attribute of the class definition implemented in the device.	3	

Class Service

Service Code	Service Name	Description of Service
0x0E	Get_Attribute_Single	Read one attribute

Instance Attribute

Instance	Attribute ID	Access	Name	Data type	Details	Value
1	2	Get	Number Available	UNIT	Maximum number of connections supported	16
	3	Get	Number active	UNIT	Number of connections currently used by system components	0

Instance Services

Service Code	Service Name	Description of Service
0x0E	Get_Attribute_Single	Read one attribute

4.3. Assembly Object (0x04)

Class code 0x04.

The Assembly Object binds attributes of multiple objects, which allows data to or from each object to be sent or received over a single connection. Assembly objects can be used to bind input data or output data. The terms "input" and "output" are defined from the network's point of view. An input will produce data on the network and an output will consume data from the network

Class Attributes

Instance	Attribute ID	Access	Name	Data type	Details	Value
0	1	Get	Revision	UINT	Revision of this object	2
	2	Get	Max Instances	UINT	Maximum instance number of an object currently created in this class level of the device.	199
	3	Get	Number of Instances	UINT	Number of object instances currently created at this class level of the device.	13
	6	Get	Max ID of class attributes	UINT	The attribute ID number of the last class attribute of the class definition implemented in the device.	7
	7	Get	Max ID of instance attribute	UINT	The attribute ID number of the last instance attribute of the class definition implemented in the device.	4

Class Service

Service Code	Service Name	Description of Service
0x0E	Get_Attribute_Single	Read one attribute

Instance Attribute

Instance	Attribute ID	Access	Name	Details
See below	3	Get/Set*	Data	Settable Only on Output Assembly. See below
See below	4	Get	Size	Number of bytes in Attribute 3.

Output Assembly:

Instance	Type	Size	Page
20	CIP basic speed control output	2 words (4 bytes)	45
21	CIP extended speed control output	2 words (4 bytes)	46
100	Native drive output	2 to 8 words (4 to 16 bytes)	47
101	Native drive output	4 words (8 bytes)	49
102	Native drive output	6 words (12 bytes)	51
105	TOSHIBA specific output	9 words (18 bytes)	52

Input Assembly:

Instance	Type	Size	Page
70	CIP basic speed control input	2 words (4 bytes)	45
71	CIP extended speed control input	2 words (4 bytes)	46
150	Native drive input	2 to 8 words (4 to 16 bytes)	47
151	Native drive input	4 words (8 bytes)	49
152	Native drive input	6 words (12 bytes)	51
155	TOSHIBA specific output	9 words (18 bytes)	52

Instance Services

Service Code	Service Name	Description of Service
0x0E	Get_Attribute_Single	Read one attribute
0x10	Set_Attribute_Single	Write one attribute

4.4. Connection Manager Object (0x06)

Class code 0x06.

Use this object for connection and connectionless communications, including establishing connections across multiple subnets.

Class Attributes

Instance	Attribute ID	Access	Name	Data type	Details	Value
0	1	Get	Revision	UINT	Revision of this object	1
	2	Get	Max Instances	UINT	Maximum instance number of an object currently created in this class level of the device.	1
	3	Get	Number of Instances	UINT	Number of object instances currently created at this class level of the device.	1
	4	Get	Optional attribute list	STRUCT of	List of optional instance attributes utilized in an object class implementation.	-
			Number of attributes	UNIT	Number of attribute in the optional attribute list.	8
			Optional attributes	ARRAY of UNIT	List of optional attribute numbers.	1, 2, 3, 4, 5, 6, 7, 8
	6	Get	Max ID of class attributes	UINT	The attribute ID number of the last class attribute of the class definition implemented in the device.	7
7	Get	Max ID of instance attribute	UINT	The attribute ID number of the last instance attribute of the class definition implemented in the device.	8	

Class Services

Service Code	Service Name	Description of Service
0x0E	Get_Attribute_Single	Read one attribute

Instance 1 Attribute

Instance	Attribute ID	Access	Name	Data type	Details
1	1	Get	Open Requests	UINT	Number of Forward Open service requests received.
	2	Get	Open Format Rejects	UINT	Number of Forward Open service requests which were rejected due to bad format.
	3	Get	Open Resources Rejects	UINT	Number of Forward Open service requests which were rejected due to lack of resources.
	4	Get	Open Other Rejects	UINT	Number of Forward Open service requests which were rejected for reasons other than bad format or lack of resources.
	5	Get	Close Requests	UINT	Number of Forward Close service requests received.
	6	Get	Close Format Requests	UINT	Number of Forward Close service requests which were rejected due to bad format.
	7	Get	Close Other Requests	UINT	Number of Forward Close service requests which were rejected for reasons other than bad format.
	8	Get	Connection Timeouts	UINT	Total number of connection timeouts that have occurred in connections controlled by this Connection Manager

Instance Services

Service Code	Service Name	Description of Service
0x0E	Get_Attribute_Single	Read one attribute
0x4E	Forward_Close	Closes a connection
0x54	Forward_Open	Opens a connection, maximum data size is 511 bytes

4.5. Motor Data Object (0x28)

Class code 0x28.

This object serves as a database for motor parameters.

Class Attributes

Instance	Attribute ID	Access	Name	Data type	Details	Value
0	1	Get	Revision	UINT	Revision of this object	1
	2	Get	Max Instances	UINT	Maximum instance number of an object currently created in this class level of the device.	1
	3	Get	Number of Instances	UINT	Number of object instances currently created at this class level of the device.	1
	6	Get	Max ID of class attributes	UINT	The attribute ID number of the last class attribute of the class definition implemented in the device.	7
	7	Get	Max ID of instance attribute	UINT	The attribute ID number of the last instance attribute of the class definition implemented in the device.	15

Class Services

Service Code	Service Name	Description of Service
0x0E	Get_Attribute_Single	Read one attribute

Instance 1 Attribute

Instance	Attribute ID	Access	Name	Data type	Details
1	1	Get	AttrNb	UINT	Number of attributes supported
	2	Get	AttrList	ARRAY of USINT	List of attributes supported 1, 2, 3, 6, 7, 8, 9, 12, 15
	3	Get	MotorType	USINT	7: Squirrel Cage Induction Motor
	6	Get/Set	RatedCurrent	UINT	Motor Rated Current ($F415$)
	7	Get/Set	RatedVoltage	UINT	Motor Rated Volt ($\mu L \mu$)
	8	Get/Set	RatedPower	UDINT	Motor rated Power ($F405$)
	9	Get/Set	RatedFreq	UINT	Motor Base Freq (μL)
	12	Get	PoleCount	UINT	Motor pole number ($F855$ (number of motor pole pair) $\times 2$)
15	Get/Set	BaseSpeed	UINT	Motor Base Speed ($F417$)	

Instance Services

Service Code	Service Name	Description of Service
0x0E	Get_Attribute_Single	Read one attribute
0x10	Set_Attribute_Single	Write one attribute

4.6. Control Supervisor Object (0x29)

Class code 0x29.

This object models all the management functions for devices within the "Hierarchy of Motor Control Devices". The behavior of motor control devices is described by the State Transition Diagram.

Class Attributes

Instance	Attribute ID	Access	Name	Data type	Details	Value
0	1	Get	Revision	UINT	Revision of this object	1
	2	Get	Max Instances	UINT	Maximum instance number of an object currently created in this class level of the device.	1
	3	Get	Number of Instances	UINT	Number of object instances currently created at this class level of the device.	1
	6	Get	Max ID of class attributes	UINT	The attribute ID number of the last class attribute of the class definition implemented in the device.	7
	7	Get	Max ID of instance attribute	UINT	The attribute ID number of the last instance attribute of the class definition implemented in the device.	15

Class Services

Service Code	Service Name	Description of Service
0x0E	Get_Attribute_Single	Read one attribute

Instance 1 Attribute

Instance	Attribute ID	Access	Name	Data type	Details
1	1	Get	Number of attributes	UINT	Number of attributes supported
	2	Get	AttrList	LIST of USINT	List of attributes supported
	3	Get/Set	Run 1	BOOL	Refer to "4.6.1 Run/Stop Event Matrix." 00 = Stop 01 = Run (On edge)
	4	Get/Set	Run 2	BOOL	Refer to "4.6.1 Run/Stop Event Matrix." 00 = Stop 01 = Run (On edge)
	5	Get/Set	NetCtrl	BOOL	Request Run/Stop control to be local or from network. 0 = Local Control(default) 1 = Network Control Note that the actual status of Run/Stop control is reflected in attribute 15, CtrlFromNet.
	6	Get	State	USINT	Refer to "4.6.2 State of the drive."
	7	Get	Running 1	BOOL	1 = (Enabled and Run1) or (Stopping and Running1) or (Fault Stop and Running1) 0 = Other state
	8	Get	Running 2	BOOL	1 = (Enabled and Run2) or (Stopping and Running2) or (Fault Stop and Running2) 0 = Other state
	9	Get	Ready	BOOL	1 = Ready or Enabled or Stopping 0 = Other state
	10	Get	Faulted	BOOL	1 = Fault Occurred (latched) 0 = No Faults present
	11	Get	Warning	BOOL	1 = Warning (not latched) 0 = No Warnings present
	12	Get/Set	FaultRst	BOOL	0->1 = Fault Reset 0 = No action
	15	Get	CtrlFromNet	BOOL	Status of Run/Stop control source. 0 = Control is local 1 = Control is from network

Instance Services

Service Code	Service Name	Description of Service
0x05	Reset	Resets the drive to the start-up state.
0x0E	Get_Attribute_Single	Read one attribute
0x10	Set_Attribute_Single	Write one attribute

4.6.1. Run/Stop Event Matrix

Run1	Run2	Trigger Event	Run Type
0	0	Stop	No Action
0 -> 1	0	Run	Run1
0	0 -> 1	Run	Run2
0 -> 1	0 -> 1	No Action	No Action
1	1	No Action	No Action
1 -> 0	1	Run	Run2
1	1 -> 0	Run	Run1

4.6.2. State of the drive

The Control Supervisor class State attribute (Att. ID= 6) shows state of the drive.

- 1 (=BN: 00000001): Startup
- 2 (=BN: 00000010): Not ready
- 3 (=BN: 00000011): Ready
- 4 (=BN: 00000100): Enabled
- 5 (=BN: 00000101): Stopping
- 6 (=BN: 00000110): Fault Stop
- 7 (=BN: 00000111): Faulted

4.6.3. Control Supervisor State Transition Diagram

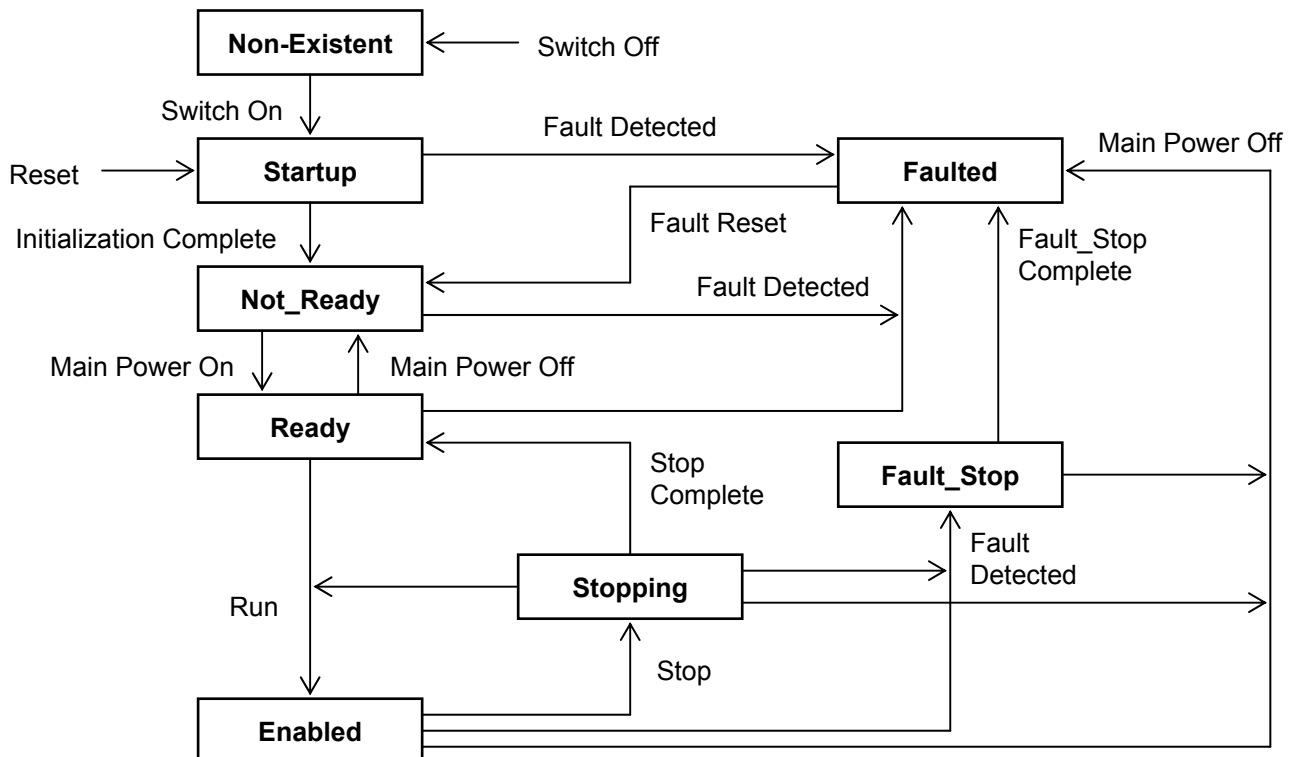

4.7. AC/DC Drive Object (0x2A)

Class code 0x2A.

This object models the functions specific to an AC or DC Drive. e.g. speed ramp, torque control etc.

Class Attributes

Instance	Attribute ID	Access	Name	Data type	Details	Value
0	1	Get	Revision	UINT	Revision of this object	1
	2	Get	Max Instances	UINT	Maximum instance number of an object currently created in this class level of the device.	1
	3	Get	Number of Instances	UINT	Number of object instances currently created at this class level of the device.	1
	6	Get	Max ID of class attributes	UINT	The attribute ID number of the last class attribute of the class definition implemented in the device.	7
	7	Get	Max ID of instance attribute	UINT	The attribute ID number of the last instance attribute of the class definition implemented in the device.	46

Class Services

Service Code	Service Name	Description of Service
0x0E	Get_Attribute_Single	Read one attribute

Instance 1 Attribute

Instance	Attribute ID	Access	Name	Data type	Details	Value or Unit
1	1	Get	NumAttr	USINT	Number of Attributes supported	19
	2	Get	Attributes	ARRAY of USINT	List of Attributes supported	1, 2, 3, 4, 6, 7, 8, 9, 10, 11, 15, 18, 19, 20, 21, 26, 28, 29, 46
	3	Get	AtReference	BOOL	1 = Drive actual at reference	-
	4	Get/Set	NetRef	BOOL	Requests torque and speed reference to be local or from the network. 0 = Set Reference not DN Control 1 = Set Reference at DN Control	-
	6	Get	Drive mode	USINT	Drive Mode	-
	7	Get	SpeedActual	INT	Actual Speed	rpm
	8	Get/Set	SpeedRef *	INT	Reference Speed	rpm
	9	Get	CurrentActual	UINT	Drive Current	0.1 A
	10	Get/Set	CurrentLimit	UINT	Drive Current Limit	0.1 A
	11	Get	Torque Actual	UINT	Drive Actual Torque	Nm
	15	Get	PowerActual	UINT	Drive Power	W
	18	Get/Set	AccelTime	UINT	Drive Acceleration	ms
	19	Get/Set	DecelTime	UINT	Drive Deceleration	ms
	20	Get/Set	LowSpdLimit	UINT	Drive minimum speed	rpm
	21	Get/Set	HighSpdLimit	UINT	Drive maximum speed	rpm
	26	Get/Set	Power scaling	UINT	Power scaling factor	0
	28	Get/Set	Time scaling	UINT	Time scaling factor	0
	29	Get	RefFromNet	BOOL	Status of speed reference 0=Local speed reference 1=Network speed reference	-
46	Get	HoursOn	UDINT	Number of hours	h	

* The output frequency of the drive follows F_H though the frequency of F_H or more can be written.

Instance Services

Service Code	Service Name	Description of Service
0x0E	Get_Attribute_Single	Read one attribute
0x10	Set_Attribute_Single	Write one attribute

4.8. Parameter Objects (0x64)

Class code 0x64. This object provides VF-MB1/ S15's Parameter access.

Range Address accessed:

Input Instance	Real Logical address in Drive accessed
0x4000-0x4FFF	0x0000-0x0FFF
0x7000-0x7FFF	0xF000-0xFFFF

Class Attributes

Instance	Attribute ID	Access	Name	Data type	Details	Value
0	1	Get	Revision	UINT	Revision of this object	1
	2	Get	Max Instances	UINT	Maximum instance number of an object currently created in this class level of the device.	32767
	3	Get	Number of Instances	UINT	Number of object instances currently created at this class level of the device.	8190
	6	Get	Max ID of class attributes	UINT	The attribute ID number of the last class attribute of the class definition implemented in the device.	7
	7	Get	Max ID of instance attribute	UINT	The attribute ID number of the last instance attribute of the class definition implemented in the device.	3

Class Services

Service Code	Service Name	Description of Service
0x0E	Get_Attribute_Single	Read one attribute

Instance 1 Attribute

Instance	Attribute ID	Access	Name	Data type	Details
See below	3	Get/Set	parameter	UINT	Parameter corresponding to the Instance address

Instance Services

Service Code	Service Name	Description of Service
0x0E	Get_Attribute_Single	Read one attribute
0x10	Set_Attribute_Single	Write one attribute

Attribute ID of all parameters are 3. Moreover, about the instance ID of each parameter, it becomes "parameter communication number + 4000H".

In the case of the parameter from which a communication number begins in "F", it becomes "parameter communication number - 0x8000 (same as bit15 set to 0)".

About the detail contents of a parameter, please refer to a VF-MB1 or VF-S15 instructions manual.

Example 1:

In case of Basic parameter "E 0 0 3 - Command mode selection",
Communication No: **0003** -> Instance ID: **4003**

Example 2:

In case of Extended parameter "F 2 6 8 - Updown frequency default value",
Communication No: **0268** -> Instance ID: **4268**

Example 3:

In case of Monitor parameter "F E 0 3 - Output current",
Communication No: **FE03** -> Instance ID: **7E03**

* Monitor parameter can access "Get" only.

For example, when "Acc. time" is set to 5 sec., since the minimum unit is 0.1s,

$$5 / 0.1 = 50 = 32H$$

Since the communication number of "Acc. time" is "0009", it writes "32H" in instance ID "4009."

Moreover, when the "highest frequency" is read, "1F40H" is read.

$$0x1F40 = 8000 \text{ (Dec.)}$$

Since the minimum unit is 0.01Hz,

$$8000 \times 0.01 = 80\text{Hz}$$

4.9. Parameter Objects (0x65)

Class code 0x65. This object provides VF-MB1/S15's Parameter access.

Range Address accessed:

Input Instance	Real Logical address in Drive accessed
0x0001-0xFFFF	0x0001-0xFFFF

* Refer to "Class Attributes" when the instance is 0.

* If you want to access the *RU 1*, please use the "Application Objects (64 hex)."

Class Attributes

Instance	Attribute ID	Access	Name	Data type	Details	Value
0	1	Get	Revision	UINT	Revision of this object	1
	2	Get	Max Instances	UINT	Maximum instance number of an object currently created in this class level of the device.	65535
	3	Get	Number of Instances	UINT	Number of object instances currently created at this class level of the device.	65535
	6	Get	Max ID of class attributes	UINT	The attribute ID number of the last class attribute of the class definition implemented in the device.	7
	7	Get	Max ID of instance attribute	UINT	The attribute ID number of the last instance attribute of the class definition implemented in the device.	3

Class Services

Service Code	Service Name	Description of Service
0x0E	Get_Attribute_Single	Read one attribute

Instance 1 Attribute

Instance	Attribute ID	Access	Name	Data type	Details
See below	3	Get/Set	parameter	UINT	Parameter corresponding to the Instance address

Instance Services

Service Code	Service Name	Description of Service
0x0E	Get_Attribute_Single	Read one attribute
0x10	Set_Attribute_Single	Write one attribute

Attribute ID of all parameters are 3. Moreover, about the instance ID of each parameter, it becomes "parameter communication number".

About the details of the contents of a parameter please refer to VF-MB1 instruction manual or VF-S15 instruction manual.

Example 1:

When "ACC. time" is set to 5 s, since the minimum unit is 0.1s,

$5 / 0.1 = 50 = 32H$

Since the communication number of "Acc. time" is "0009", it writes "32H" is instance ID "0009."

4.10. Port Object (0xF4)

Class code 0xF4.

The Port Object enumerates the CIP ports present on the device.

One instance exists for each CIP port.

Class Attributes

Instance	Attribute ID	Access	Name	Data type	Details	Value
0	1	Get	Revision	UINT	Revision of this object	1
	2	Get	Max Instances	UINT	Maximum instance number of an object currently created in this class level of the device.	1
	3	Get	Number of Instances	UINT	Number of object instances currently created at this class level of the device.	1
	6	Get	Max ID of class attributes	UINT	The attribute ID number of the last class attribute of the class definition implemented in the device.	9
	7	Get	Max ID of instance attribute	UINT	The attribute ID number of the last instance attribute of the class definition implemented in the device.	7
	8	Get	Entry Port	UINT	Returns the instance of the Port Object that describes the port through which this request entered the device.	1
	9	Get	All Ports	STRUCT of Port Type Port Number	Array of structures containing instance attributes 1 and 2 from each instance.	0000 0000 0000 0200

Note: Attribute 9

00 00 00 00 -> port type = 0 (Connection terminated)

/ instance number = 0 (class)

00 00 02 00 -> port type = 2 (TCP/IP Port)

/ port number = 2

Class Services

Service Code	Service Name	Description of Service
0x01	Get_Attribute_All	Read all attributes
0x0E	Get_Attribute_Single	Read one attribute

Instance 1 Attribute

Instance	Attribute ID	Access	Name	Data type	Details	Value
1	1	Get	Port Type	UINT	Enumerate the type of port. (0 = TCP/IP)	0
	2	Get	Port Number	UINT	CIP port associated with this port (identify each communication port). Value '1' is reserved.	2
	3	Get	Link Object	STRUCT of UINT Padded EPATH	Identify Object attached to this port. For EtherNet/IP, this path corresponds to TCP/IP Interface object.	02 00 20 F5 24 01
	4	Get	Port Name	SHORT_STRING	String which names the port. 11, EtherNet/IP	0B 45 74 68 65 72 4E 65 74 2F 49 50
	7	Get	Node address	Padded EPATH	Node number of this device on port. The range within this data type is restricted to a Port Segment.	-

Instance Services

Service Code	Service Name	Description of Service
0x01	Get_Attribute_All	Read all attributes
0x0E	Get_Attribute_Single	Read one attribute

4.11. TCP/IP interface Object (0xF5)

Class code 0xF5.

The TCP/IP Interface Object provides the mechanism to configure a device's TCP/IP network interface.

Class Attributes

Instance	Attribute ID	Access	Name	Data type	Details	Value
0	1	Get	Revision	UINT	Revision of this object	1
	2	Get	Max Instances	UINT	Maximum instance number of an object currently created in this class level of the device.	1
	3	Get	Number of Instances	UINT	Number of object instances currently created at this class level of the device.	1
	4	Get	Optional attribute list	STRUCT of	List of optional instance attributes utilized in an object class implementation.	-
			Number of attributes	UNIT	Number of attribute in the optional attribute list.	2
			Optional attributes	ARRAY of UINT	List of optional attribute numbers.	8, 9
	5	Get	Optional service list	STRUCT of	List of optional services utilized in an object class implementation.	-
			number services	UINT	Number of services in the optional service list.	0
			optional services	ARRAY of UINT	List of optional service codes.	-
	6	Get	Max ID of class attributes	UINT	The attribute ID number of the last class attribute of the class definition implemented in the device.	7
7	Get	Max ID of instance attribute	UINT	The attribute ID number of the last instance attribute of the class definition implemented in the device.	9	

Class Services

Service Code	Service Name	Description of Service
0x01	Get_Attribute_All	Read all attributes
0x0E	Get_Attribute_Single	Read one attribute

Instance 1 Attribute

Instance	Attribute ID	Access	Name	Data type	Details
1	1	Get	Status	DWORD	Bits 0 -3 : Interface configuration 000 : The Interface Configuration attribute has not been configured. 001 : The Interface Configuration attribute contains valid configuration. Bit 6 : ACD Status 0 (Clear) : No Address conflict Detected 1 (Set) : Address conflict Detected
	2	Get	Configuration capability	DWORD	Bit 0 = 1 (TRUE) shall indicate the device is capable of obtaining its network configuration via BOOTP. Bit 1 = 1 (TRUE) shall indicate the device is capable of resolving host names by querying a DNS server. Bit 2 = 1 (TRUE) shall indicate the device is capable of obtaining its network configuration via DHCP. Bit 3 = 1 (TRUE) shall indicate the device is capable of sending its host name in the DHCP request. Bit 4 = 1 (TRUE) shall indicate the Interface Configuration attribute is settable. Bit 7 = 1 (TURE) shall indicate that the device is ACD capable. Bit 5,6 and 8-31 : (System reserved)
	3	Get/Set	Configuration control	DWORD	Bits 0-3 : Start-up configuration 000 : The device shall use the interface configuration values previously stored. 001 : The device shall obtain its interface configuration values via BOOTP. 010 : The device shall obtain its interface configuration values via DHCP upon start-up. 011-111 : Unused Bit 4 = 1 (TRUE), the device shall resolve host names by querying a DNS server. Bit 5-31 : (System reserved)
	4	Get	Physical Link Object	STRUCT of UINT EPATH	Path Size Path: Logical segments identifying the physical link object Example [20][F6][24][01] : [20] = 8 bit class segment type; [F6] = Ethernet Link Object class; [24] = 8 bit instance segment type; [01] = instance 1.
	5	Get/Set	Interface Configuration	STRUCT of	TCP/IP network interface configuration *
			IP Address	UDINT	IP address (0 : no address configured)
			Network Mask	UDINT	Network Mask (0 : no Network mask configured)
			Gateway Address	UDINT	Gateway IP address (0 : no address configured)
			Name Server	UDINT	Name server address (0 : no address configured)
			Name Server 2	UDINT	Name server address 2 (0 : no address configured)
6	Get/Set	Host Name	STRING	Device Name**	
8	Get/Set	TTL value	USINT	TTL value for EtherNet/IP multicast packets.	

* The processing time of this Set service is about two seconds.

Please do not turn off the power supply, and do not use the other services without response from this Set service.

** Only 16 characters in 64 characters can be set in the drive.

Instance	Attribute ID	Access	Name	Data type	Details
1	9	Get/Set	Mcast Config	STRUCT of	IP Multicast address configuration
			Alloc Config	USINT	0 - Use default allocation algorithm to generate multicast addresses. 1 - Multicast addresses shall be allocated according to the values in Num Mcast and Mcast Start Address.
			Reserved	USINT	(System reserved)
			Num Mcast	UINT	Number of multicast addressees to allocate for EtherNet/IP.
			Mcast Start Addr	UDINT	Starting multicast address from which to begin allocation.
	10	Get/Set	SelectedAcd	BOOL	Activate the use of ACD 0 - Disable ACD 1 - Enable ACD
	11	Get/Set	LastConflictDeteced	STRUCT of	Structure containing information related to the last conflict detected.
			AcdActivity	USINT	State of ACD activity when last conflict detected.
			RemoteMAC	Array of 6 USINT	MAC address of remote node from the ARP PDU in which a conflict was detected.
			ArpPdu	Array of 28 USINT	Copy of the raw ARP PDU in which a conflict was detected.

Note: Don't use the "System reserved" bit and Bit0 for the judgement.

Instance Services

Service Code	Service Name	Description of Service
0x01	Get_Attribute_All	Read all attributes
0x0E	Get_Attribute_Single	Read one attribute
0x10	Set_Attribute_Single	Write one attribute

4.12. Ethernet link object (0xF6)

Class code 0xF6:

The Ethernet Link Object maintains link-specific counters and status information for IEEE 802.3 communications interface.

Class Attributes

Instance	Attribute ID	Access	Name	Data type	Details	Value
0	1	Get	Revision	UINT	Revision of this object	3
	2	Get	Max Instances	UINT	Maximum instance number of an object currently created in this class level of the device.	2
	3	Get	Number of Instances	UINT	Number of object instances currently created at this class level of the device.	2
	6	Get	Max ID of class attributes	UINT	The attribute ID number of the last class attribute of the class definition implemented in the device.	7
	7	Get	Max ID of instance attribute	UINT	The attribute ID number of the last instance attribute of the class definition implemented in the device.	10

Class Services

Service Code	Service Name	Description of Service
0x01	Get_Attribute_All	Read all attributes
0x0E	Get_Attribute_Single	Read one attribute

Instance 1 Attribute

Instance	Attribute ID	Access	Name	Data type	Details
1	1	Get	Interface Speed	UDINT	Interface speed currently in use 0 : indeterminate (Auto baudrate) 10: 10Mbps 100: 100Mbps
	2	Get	Interface Flags	DWORD	<p>Bit 0 : Link Status Indicates whether or not the Ethernet 802.3 communications interface is connected to an active network. 0 indicates an inactive link; 1 indicates an active link.</p> <p>Bit 1 : Half/Full Duplex Indicates the duplex mode currently in use. 0 indicates the interface is running half duplex; 1 indicates full duplex.</p> <p>Bit 2-4 : Negotiation Status 000 : Auto-negotiation in progress. 001 : Auto-negotiation and speed detection failed. 010 : Auto negotiation failed but detected speed. Duplex was defaulted. 011 : Successfully negotiated speed and duplex. 100 : Auto-negotiation not attempted. Forced speed and duplex. 101-111 : Unused</p> <p>Bit 5 : Manual Setting Requires Reset. 0 indicates the interface can activate changes to link parameters (auto-negotiate, duplex mode, interface speed) automatically. 1 indicates the device requires a Reset service be issued to its Identity Object in order for the changes to take effect.</p> <p>Bit 6: Local Hardware Fault. 0 indicates the interface detects no local hardware fault 1 indicates a local hardware fault is detected. The meaning of this is product-specific.</p> <p>Bit 7-31 : (System reserved)</p>
	3	Get	Physical Address	ARRAY of 6 USINTs	MAC layer address
	4	Get	Interface Counters	STRUCT of	
	In Octets		UDINT	Octets received on the interface	
	In Ucast Packets		UDINT	Unicast packets received on the interface	
	In NUcast Packets		UDINT	Non-unicast packets received	
	In Discards		UDINT	Inbound packets received on the interface but discarded	
	In Errors		UDINT	Inbound packets that contain errors (does not include In Discards)	
	In Unknown Protos		UDINT	Inbound packets with unknown protocol	
	Out Octets		UDINT	Octets sent on the interface	
	Out Ucast Packets		UDINT	Unicast packets sent on the interface	
	Out NUcast Packets		UDINT	Non-unicast packets sent on the interface	
	Out Discards	UDINT	Outbound packets discarded		
Out Errors	UDINT	Outbound packets that contain errors			

Note: Don't use the "System reserved" bit and Bit0 for the judgement.

Instance	Attribute ID	Access	Name	Data type	Details
1	5	Get	Media Counters	STRUCT of	Media-specific counters
			Alignment Errors	UDINT	Frames received that are not an integral number of octets in length
			FCS Errors	UDINT	Frames received that do not pass the FCS check
			Single Collisions	UDINT	Successfully transmitted frames which experienced exactly one collision
			Multiple Collisions	UDINT	Successfully transmitted frames which experienced more than one collision
			SQE Test Errors	UDINT	Number of times SQE test error message is generated
			Deferred Transmissions	UDINT	Frames for which first transmission attempt is delayed because the medium is busy
			Late Collisions	UDINT	Number of times a collision is detected later than 512 bit times into the transmission of a packet
			Excessive Collisions	UDINT	Frames for which transmission fails due to excessive collisions
			MAC Transmit Errors	UDINT	Frames for which transmission fails due to an internal MAC sublayer transmit error
			Carrier Sense Errors	UDINT	Times that the carrier sense condition was lost or never asserted when attempting to transmit a frame
			Frame Too Long	UDINT	Frames received that exceed the maximum permitted frame size
	MAC Receive Errors	UDINT	Frames for which reception on an interface fails due to an internal MAC sublayer receive error		
	6	Set	Interface Control	STRUCT of	Configuration for physical interface
Control Bits			WORD	Interface Control Bits	
Forced Interface Speed			UINT	Speed at which the interface shall be forced to operate	
7	Get	Interface Type	USINT	Type of interface: twisted pair, fiber, internal, etc.	
10	Get	Interface Label	SHORT_S TRING	Human readable identification 4, Left	

Instance 2 Attribute

Instance	Attribute ID	Access	Name	Data type	Details
2	1	Get	Interface Speed	UDINT	Interface speed currently in use 0: indeterminate (Auto baudrate) 10: 10Mbps 100: 100Mbps
	2	Get	Interface Flags	DWORD	Bit 0: Link Status Indicates whether or not the Ethernet 802.3 communications interface is connected to an active network. 0 indicates an inactive link; 1 indicates an active link. Bit 1: Half/Full Duplex Indicates the duplex mode currently in use. 0 indicates the interface is running half duplex; 1 indicates full duplex. Bit 2-4: Negotiation Status 000 : Auto-negotiation in progress. 001 : Auto-negotiation and speed detection failed. 010 : Auto negotiation failed but detected speed. Duplex was defaulted. 011 : Successfully negotiated speed and duplex. 100 : Auto-negotiation not attempted. Forced speed and duplex. Bit 5: Manual Setting Requires Reset. 0 indicates the interface can activate changes to link parameters (auto-negotiate, duplex mode, interface speed) automatically. 1 indicates the device requires a Reset service be issued to its Identity Object in order for the changes to take effect. Bit 6: Local Hardware Fault. 0 indicates the interface detects no local hardware fault 1 indicates a local hardware fault is detected. The meaning of this is product-specific. Bit 7-31 (System reserved)
	3	Get	Physical Address	ARRAY of 6 USINTs	MAC layer address
	6	Get/Set	Interface Control	STRUCT of	Configuration for physical interface
			Control Bits	WORD	Interface Control Bits
			Forced Interface Speed	UINT	Speed at which the interface shall be forced to operate
7	Get	Interface Type	USINT	Type of interface: twisted pair, fiber, internal, etc.	
10	Get	Interface Label	SHORT_STRING	Human readable identification 5, Right	

Note: Don't use the "System reserved" bit and Bit0 for the judgement.

Instance Services

Service Code	Service Name	Description of Service
0x01	Get_Attribute_All	Read all attributes
0x0E	Get_Attribute_Single	Read one attribute
0x10	Set_Attribute_Single	Write one attribute
0x4C	Get_and_Clear	Gets then clears the specified attribute (Interface Counters or Media Counters).

5. Configuration of the assemblies

5.1. List of Assembly Object Instance

Output Instance

Instance name	Number (Hex)	Size
CIP basic speed control output	20 (0x14)	2 words (4 bytes)
CIP extended speed control output	21 (0x15)	2 words (4 bytes)
Native drive output	100 (0x64)	2 to 8 words (4 to 16 bytes)
Native drive output	101 (0x65)	4 words (8 bytes)
Native drive output	102 (0x66)	6 words (12 bytes)
TOSHIBA specific output	105 (0x69)	9 words (18 bytes)

Input Instance

Instance name	Number (Hex)	Size
CIP basic speed control input	70 (0x46)	2 words (4 bytes)
CIP extended speed control input	71 (0x47)	2 words (4 bytes)
Native drive input	150 (0x96)	2 to 8 words (4 to 16 bytes)
Native drive input	151 (0x97)	4 words (8 bytes)
Native drive input	152 (0x98)	6 words (12 bytes)
TOSHIBA specific input	155 (0x9B)	9 words (18 bytes)

5.1.1. Instance 20: CIP basic speed control output

Instance 20 mapping

Byte	Bit 7	Bit 6	Bit 5	Bit 4	Bit 3	Bit 2	Bit 1	Bit 0
0	-	-	-	-	-	Fault reset	-	Run Fwd
1	-							
2	Drive Speed Reference min ⁻¹ (Low byte) *							
3	Drive Speed Reference min ⁻¹ (High byte) *							

5.1.2. Instance 70: CIP basic speed control input

Instance 70 mapping

Byte	Bit 7	Bit 6	Bit 5	Bit 4	Bit 3	Bit 2	Bit 1	Bit 0
0	-	-	-	-	-	Running1* (Fwd)	-	Faulted
1	-							
2	Drive Actual Speed min ⁻¹ (Low byte)							
3	Drive Actual Speed min ⁻¹ (High byte)							

* Running1 means "Running Forward."

Examples of Instance 20/70

(1) Stop

Instance	Byte	15	14	13	12	11	10	9	8	7	6	5	4	3	2	1	0	Hex.
Output Instance 20	1, 0	0	0	0	0	0	0	0	0	0	0	0	0	0	0	0	0	0x0000
	3, 2	-	-	-	-	-	-	-	-	-	-	-	-	-	-	-	-	-
Input Instance 70	1, 0	0	0	0	0	0	0	0	0	0	0	0	0	0	0	0	0	0x0000
	3, 2	0	0	0	0	0	0	0	0	0	0	0	0	0	0	0	0	0x0000

(2) Forward running 1800 rpm **

Instance	Byte	15	14	13	12	11	10	9	8	7	6	5	4	3	2	1	0	Hex.
Output Instance 20	1, 0	0	0	0	0	0	0	0	0	0	0	0	0	0	0	0	1	0x0001
	3, 2	0	0	0	0	0	1	1	1	0	0	0	0	1	0	0	0	0x0708
Input Instance 70	1, 0	0	0	0	0	0	0	0	0	0	0	0	0	0	1	0	0	0x0004
	3, 2	0	0	0	0	0	1	1	1	0	0	0	0	1	0	0	0	0x0708

(3) Fault reset ***

Instance	Byte	15	14	13	12	11	10	9	8	7	6	5	4	3	2	1	0	Hex.
Output Instance 20	1, 0	0	0	0	0	0	0	0	0	0	0	0	0	0	1	0	0	0x0004
	3, 2	-	-	-	-	-	-	-	-	-	-	-	-	-	-	-	-	-

** Drive Reference Speed is set up number of rotations by the hexadecimal number.

For example, when "Frequency reference" is set up to 1800 min⁻¹:

1800 = 708H

*** Fault reset works only 1 time when 0 -> 1.

5.1.3. Instance 21: CIP extended speed control output

Instance 21 mapping

Byte	Bit 7	Bit 6	Bit 5	Bit 4	Bit 3	Bit 2	Bit 1	Bit 0
0	-	NetRef *	NetCtrl *	-	-	Fault reset	Run Rev	Run Fwd
1	-							
2	Drive Reference Speed min ⁻¹ (Low byte)							
3	Drive Reference Speed min ⁻¹ (High byte)							

* Bit 5 and 6 of the instance 21 byte 0 are defined as follows.

Bit 5 (Net Ctrl)..... When “1” is set, bits 0 (Run forward) and 1 (Run reverse) of byte 0 are enabled. When “0” is set, Run/Stop is according to setup of the parameter *CNOd*.

Bit 6 (Net Ref)..... When “1” is set, bytes 2 and 3 are enabled. When “0” is set, Drive Reference Speed is according to setup of the parameter *FNOd*.

5.1.4. Instance 71: CIP extended speed control input

Instance 71 mapping

Byte	Bit 7	Bit 6	Bit 5	Bit 4	Bit 3	Bit 2	Bit 1	Bit 0
0	At Reference **	Ref From Net **	Ctrl From Net **	Ready	Running2 (Rev)	Running1 (Fwd)	Warning	Faulted
1	Drive Status ***)							
2	Drive Reference Speed min ⁻¹ (Low byte)							
3	Drive Reference Speed min ⁻¹ (High byte)							

** Bit 5, 6, and 7 of the instance 71 byte 0 are defined as follows.

Bit 5 (Ctrl from Net).....When RUN/STOP command from EtherNet/IP is enabled, “1” is set.

Bit 6 (Ref from Net).....When frequency command from EtherNet/IP is enabled, “1” is set.

Bit 7 (At reference)When output frequency becomes the same as frequency command, “1” is set.

*** Drive Status is same as the Control Supervisor class State attribute (refer to section 4.6.2).

■ Examples of Instance 21/71

(1) Stop

Instance	Byte	15	14	13	12	11	10	9	8	7	6	5	4	3	2	1	0	Hex.
Output Instance 21	1, 0	0	0	0	0	0	0	0	0	0	0	0	0	0	0	0	0	0x0000
	3, 2	-	-	-	-	-	-	-	-	-	-	-	-	-	-	-	-	-
Input Instance 71	1, 0	0	0	0	0	0	0	1	1	0	0	0	1	0	0	0	0	0x0310
	3, 2	0	0	0	0	0	0	0	0	0	0	0	0	0	0	0	0	0x0000

(2) Forward running 1800 min⁻¹

Instance	Byte	15	14	13	12	11	10	9	8	7	6	5	4	3	2	1	0	Hex.
Output Instance 21	1, 0	0	0	0	0	0	0	0	0	0	1	1	0	0	0	0	1	0x0061
	3, 2	0	0	0	0	0	1	1	1	0	0	0	0	1	0	0	0	0x0708
Input Instance 71	1, 0	0	0	0	0	0	1	0	0	1	1	1	1	0	1	0	0	0x04F4
	3, 2	0	0	0	0	0	1	1	1	0	0	0	0	1	0	0	0	0x0708

(3) Fault reset *

Instance	Byte	15	14	13	12	11	10	9	8	7	6	5	4	3	2	1	0	Hex.
Output Instance 21	1, 0	0	0	0	0	0	0	0	0	0	0	0	0	0	1	0	0	0x0004
	3, 2	-	-	-	-	-	-	-	-	-	-	-	-	-	-	-	-	-

* Fault reset works only 1 time when 0 -> 1.

5.1.5. Instance 100: Native drive output

Instance 100 mapping

Byte	Bit 7	Bit 6	Bit 5	Bit 4	Bit 3	Bit 2	Bit 1	Bit 0
0	DC braking	ACC1/ ACC2	PI off	THR2	Preset Speed4	Preset Speed3	Preset Speed2	Preset Speed1
1	Net Ctrl*	Net Ref *	Reset trip	Emergency stop	Free run (ST)	Run/stop	Forward/ Reverse	Jog
2	Drive Reference Speed Hz (Low byte) **							
3	Drive Reference Speed Hz (High byte) **							

* Bit 6 and 7 of the instance 100 byte 1 are defined as follows.

Bit 7 (Net Ctrl)..... When “1” is set, all commands of byte 0 and 1 are enabled. When “0” is set, each command is according to setup of the parameter $CnCd$.

Bit 6 (Net Ref)..... When “1” is set, bytes 2 and 3 are enabled. When “0” is set, Drive Reference Speed is according to setup of the parameter Fnd .

** Drive Reference Speed is set up by 0.01Hz unit and the hexadecimal number.

For example, when "Frequency reference" is set up to 60Hz, since the minimum unit is 0.01Hz,
 $60 / 0.01 = 6000 = 1770H$

5.1.6. Instance 150: Native drive input

Instance 150 mapping

Byte	Bit 7	Bit 6	Bit 5	Bit 4	Bit 3	Bit 2	Bit 1	Bit 0
0	DC braking	ACC2	PI	THR 2 (ωF^2 + kH^2)	-	ALARM (Fci)	EMG	FL
1	-	READY without ST/RUN	READY with ST/ RUN	Emergency stop	Free run (ST)	Run/Stop	Forward / Reverse	Jog
2	Drive Actual Speed Hz (Low byte)							
3	Drive Actual Speed Hz (High byte)							

■ Examples of Instance 100/150

Stop

Instance	Byte	15	14	13	12	11	10	9	8	7	6	5	4	3	2	1	0	Hex.
Output Instance 100	1, 0	0	0	0	0	0	0	0	0	0	0	0	0	0	0	0	0	0x0000
	3, 2	-	-	-	-	-	-	-	-	-	-	-	-	-	-	-	-	-
Input Instance 150	1, 0	0	1	0	0	1	0	0	0	0	0	0	0	0	0	0	0	0x4800
	3, 2	0	0	0	0	0	0	0	0	0	0	0	0	0	0	0	0	0x0000

Forward running 60Hz

Instance	Byte	15	14	13	12	11	10	9	8	7	6	5	4	3	2	1	0	Hex.
Output Instance 100	1, 0	1	1	0	0	0	1	0	0	0	0	0	0	0	0	0	0	0xC400
	3, 2	0	0	0	1	0	1	1	1	0	1	1	1	0	0	0	0	0x1770
Input Instance 150	1, 0	0	1	1	0	0	1	0	0	0	0	0	0	0	0	0	0	0x6400
	3, 2	0	0	0	1	0	1	1	1	0	1	1	1	0	0	0	0	0x1770

Reverse running 60Hz

Instance	Byte	15	14	13	12	11	10	9	8	7	6	5	4	3	2	1	0	Hex.
Output Instance 100	1, 0	1	1	0	0	0	1	1	0	0	0	0	0	0	0	0	0	0xC600
	3, 2	0	0	0	1	0	1	1	1	0	1	1	1	0	0	0	0	0x1770
Input Instance 150	1, 0	0	1	1	0	0	1	1	0	0	0	0	0	0	0	0	0	0x6600
	3, 2	0	0	0	1	0	1	1	1	0	1	1	1	0	0	0	0	0x1770

Preset speed 1 with forward running ($\underline{5r}$ i)

Instance	Byte	15	14	13	12	11	10	9	8	7	6	5	4	3	2	1	0	Hex.
Output Instance 100	1, 0	1	0	0	0	0	1	0	0	0	0	0	0	0	0	0	1	0x8401
	3, 2	-	-	-	-	-	-	-	-	-	-	-	-	-	-	-	-	-
Input Instance 150 ($\underline{5r}$ i is set 5Hz.)	1, 0	0	1	1	0	0	1	0	0	0	0	0	0	0	0	0	0	0x6400
	3, 2	0	0	0	0	0	0	0	1	1	1	1	1	0	1	0	0	0x01F4

Fault reset *

Instance	Byte	15	14	13	12	11	10	9	8	7	6	5	4	3	2	1	0	Hex.
Output Instance 100	1, 0	0	0	1	0	0	0	0	0	0	0	0	0	0	0	0	0	0x2000
	3, 2	-	-	-	-	-	-	-	-	-	-	-	-	-	-	-	-	-

About the other command, refer to section 3.2.4.2.

* Fault reset works only 1 time when 0 -> 1.

5.1.7. Instance 101: Native drive output

Instance 101 mapping

Byte	Bit 7	Bit 6	Bit 5	Bit 4	Bit 3	Bit 2	Bit 1	Bit 0
0	-	Net Ref*	Net Ctrl*	-	-	Fault reset	Run reverse	Run forward
1	-							
2	Drive Reference Speed min^{-1} (Low byte)							
3	Drive Reference Speed min^{-1} (High byte)							
4	Index (Low byte)							
5	Write	Index (High byte)						
6	Data (Low byte)							
7	Data (High byte)							

* Bit 5 and 6 of the instance 101 byte 0 are defined as follows.

Bit 5 (Net Ctrl)..... When “1” is set, all commands of byte 0 and 1 are enabled. When “0” is set, each command is according to setup of the parameter $\underline{C} \underline{N} \underline{C} \underline{d}$.

Bit 6 (Net Ref)..... When “1” is set, bytes 2 and 3 are enabled. When “0” is set, Drive Reference Speed is according to setup of the parameter $\underline{F} \underline{N} \underline{R} \underline{d}$.

5.1.8. Instance 151: Native drive input

Instance 151 mapping

Byte	Bit 7	Bit 6	Bit 5	Bit 4	Bit 3	Bit 2	Bit 1	Bit 0
0	At reference**	Ref from Net**	Ctrl from Net**	Ready	Running Reverse	Running Forward	Warning	Faulted/tripped
1	Drive Status *							
2	Drive Actual Speed min^{-1} (Low byte)							
3	Drive Actual Speed min^{-1} (High byte)							
4	Index (Low byte)							
5	Write	Error	Index (High byte)					
6	Data (Low byte)							
7	Data (High byte)							

* Drive Status is same as the Control Supervisor class State attribute (refer to 4.6.2).

** Bit 5, 6, and 7 of the instance 151 byte 0 are defined as follows.

Bit 5 (Ctrl from Net).....When command from communication is enabled, “1” is set.

Bit 6 (Ref from Net).....When frequency command from communication is enabled, “1” is set.

Bit 7 (At reference)When output frequency becomes the same as frequency command, “1” is set.

■ Examples of Instance 101/151

Access the inverter parameter is enabled using byte 4 to 6 of this Instance.

Set the communication number of the parameter to byte 4, 5 (Index), and the value to byte 6, 7 (Data).

① Read the parameter $Cn0d$ (Command mode selection, communication number is 0003).

Instance	Byte	15	14	13	12	11	10	9	8	7	6	5	4	3	2	1	0	Hex.
Output Instance 101	5, 4	0	0	0	0	0	0	0	0	0	0	0	0	0	0	1	1	0x0003
	7, 6	-	-	-	-	-	-	-	-	-	-	-	-	-	-	-	-	-
Input Instance 151 ($Cn0d$ is 0.)	5, 4	0	0	0	0	0	0	0	0	0	0	0	0	0	0	1	1	0x0003
	7, 6	0	0	0	0	0	0	0	0	0	0	0	0	0	0	0	0	0x0000

② Read the parameter $F26B$ (Initial value of UP/DOWN frequency).

Instance	Byte	15	14	13	12	11	10	9	8	7	6	5	4	3	2	1	0	Hex.
Output Instance 101	5, 4	0	0	0	0	0	0	1	0	0	1	1	0	1	0	0	0	0x0268
	7, 6	-	-	-	-	-	-	-	-	-	-	-	-	-	-	-	-	-
Input Instance 151 ($F26B$ is 60.0Hz.)	5, 4	0	0	0	0	0	0	1	0	0	1	1	0	1	0	0	0	0x0268
	7, 6	0	0	0	1	0	1	1	1	0	1	1	1	0	0	0	0	0x1770

③ Write "60 (Hz)" to the parameter $5r1$ (Preset speed 1, communication number is 0018).

Instance	Byte	15	14	13	12	11	10	9	8	7	6	5	4	3	2	1	0	Hex.
Output Instance 101	5, 4	1	0	0	0	0	0	0	0	0	0	0	1	1	0	0	0	0x8018
	7, 6	0	0	0	1	0	1	1	1	0	1	1	1	0	0	0	0	0x1770
Input Instance 151 (OK)	5, 4	1	0	0	0	0	0	0	0	0	0	0	1	1	0	0	0	0x8018
	7, 6	0	0	0	1	0	1	1	1	0	1	1	1	0	0	0	0	0x1770
Input Instance 151 (NG) (Error code *)	5, 4	1	1	0	0	0	0	0	0	0	0	0	1	1	0	0	0	0xC018
	7, 6	0	0	0	1	0	0	0	1	0	0	0	0	0	0	0	0	0x1100

*Data of "Error code"

0x1100: Data out of range

0x1101: Bad address

5.1.9. Instance 102: Native drive output

Instance 102 mapping

Byte	Bit 7	Bit 6	Bit 5	Bit 4	Bit 3	Bit 2	Bit 1	Bit 0
0								<i>⓪001</i> Command data (Low byte)
1								<i>⓪001</i> Command data (High byte)
2								<i>⓪002</i> Command data (Low byte)
3								<i>⓪002</i> Command data (High byte)
4								<i>⓪003</i> Command data (Low byte)
5								<i>⓪003</i> Command data (High byte)
6								<i>⓪004</i> Command data (Low byte)
7								<i>⓪004</i> Command data (High byte)
8								<i>⓪005</i> Command data (Low byte)
9								<i>⓪005</i> Command data (High byte)
10								<i>⓪006</i> Command data (Low byte)
11								<i>⓪006</i> Command data (High byte)

Refer to "Scanner Address (*⓪001* – *⓪006*)"

5.1.10. Instance 152: Native drive input

Instance 152 mapping

Byte	Bit 7	Bit 6	Bit 5	Bit 4	Bit 3	Bit 2	Bit 1	Bit 0
0								<i>⓪021</i> Monitor data (Low byte)
1								<i>⓪021</i> Monitor data (High byte)
2								<i>⓪022</i> Monitor data (Low byte)
3								<i>⓪022</i> Monitor data (High byte)
4								<i>⓪023</i> Monitor data (Low byte)
5								<i>⓪023</i> Monitor data (High byte)
6								<i>⓪024</i> Monitor data (Low byte)
7								<i>⓪024</i> Monitor data (High byte)
8								<i>⓪025</i> Monitor data (Low byte)
9								<i>⓪025</i> Monitor data (High byte)
10								<i>⓪026</i> Monitor data (Low byte)
11								<i>⓪026</i> Monitor data (High byte)

Refer to "Scanner Address (*⓪021* – *⓪026*)"

5.1.11. Instance 105: TOSHIBA specific output

Instance 105 mapping

Byte	Bit 7	Bit 6	Bit 5	Bit 4	Bit 3	Bit 2	Bit 1	Bit 0
0								
1	Function code (Read / Write) *							
2	Index (Low byte)							
3	Index (High byte)							
4	Data (Low byte)							
5	Data (High byte)							
6	C001 Command data (Low byte)							
7	C001 Command data (High byte)							
8	C002 Command data (Low byte)							
9	C002 Command data (High byte)							
10	C003 Command data (Low byte)							
11	C003 Command data (High byte)							
12	C004 Command data (Low byte)							
13	C004 Command data (High byte)							
14	C005 Command data (Low byte)							
15	C005 Command data (High byte)							
16	C006 Command data (Low byte)							
17	C006 Command data (High byte)							

Refer to "Scanner Address (C001 – C006) and Scanner Value (C041 – C046: details of command data)."

5.1.12. Instance 155: TOSHIBA specific input

Instance 105 mapping

Byte	Bit 7	Bit 6	Bit 5	Bit 4	Bit 3	Bit 2	Bit 1	Bit 0
0								
1	Function code (Read / Write) results							
2	Index (Low byte)							
3	Index (High byte)							
4	Data (Low byte)							
5	Data (High byte)							
6	C021 Command data (Low byte)							
7	C021 Command data (High byte)							
8	C022 Command data (Low byte)							
9	C022 Command data (High byte)							
10	C023 Command data (Low byte)							
11	C023 Command data (High byte)							
12	C024 Command data (Low byte)							
13	C024 Command data (High byte)							
14	C025 Command data (Low byte)							
15	C025 Command data (High byte)							
16	C026 Command data (Low byte)							
17	C026 Command data (High byte)							

Refer to "Scanner Address (C021 – C026) and Scanner Value (C061 – C066: details of command data)."

*: Please set the function code as follow.

Read: 0x00

Write: 0x80

■ Examples of Instance 105/155

Access the inverter parameter is enabled using byte 1 to 5 of this Instance.
Set the communication number of the parameter to byte 2, 3 (Index), and the value to byte 4, 5 (Data).

① Read the parameter $C\bar{1}0d$ (Command mode selection, communication number is 0003).

Instance	Byte	15	14	13	12	11	10	9	8	7	6	5	4	3	2	1	0	Hex.
Output Instance 105	1, 0	0	0	0	0	0	0	0	0	0	0	0	0	0	0	0	0	0x0000
	3, 2	0	0	0	0	0	0	0	0	0	0	0	0	0	0	1	1	0x0003
	5, 4	-	-	-	-	-	-	-	-	-	-	-	-	-	-	-	-	-
Input Instance 155 ($C\bar{1}0d$ is 0.)	1, 0	0	0	0	0	0	0	0	0	0	0	0	0	0	0	0	0	0x0000
	3, 2	0	0	0	0	0	0	0	0	0	0	0	0	0	0	1	1	0x0003
	5, 4	0	0	0	0	0	0	0	0	0	0	0	0	0	0	0	0	0x0000

② Read the parameter $F\bar{2}5B$ (Initial value of UP/DOWN frequency).

Instance	Byte	15	14	13	12	11	10	9	8	7	6	5	4	3	2	1	0	Hex.
Output Instance 105	1, 0	0	0	0	0	0	0	0	0	0	0	0	0	0	0	0	0	0x0000
	3, 2	0	0	0	0	0	0	1	0	0	1	1	0	1	0	0	0	0x0268
	5, 4	-	-	-	-	-	-	-	-	-	-	-	-	-	-	-	-	-
Input Instance 155 ($F\bar{2}5B$ is 60.0Hz.)	1, 0	0	0	0	0	0	0	0	0	0	0	0	0	0	0	0	0	0x0000
	3, 2	0	0	0	0	0	0	1	0	0	1	1	0	1	0	0	0	0x0268
	5, 4	0	0	0	1	0	1	1	1	0	1	1	1	0	0	0	0	0x1770

③ Write "60 (Hz)" to the parameter $S\bar{r}1$ (Preset speed 1, communication number is 0018).

Instance	Byte	15	14	13	12	11	10	9	8	7	6	5	4	3	2	1	0	Hex.
Output Instance 105	1, 0	1	0	0	0	0	0	0	0	0	0	0	0	0	0	0	0	0x8000
	3, 2	0	0	0	0	0	0	0	0	0	0	0	1	1	0	0	0	0x0018
	5, 4	0	0	0	1	0	1	1	1	0	1	1	1	0	0	0	0	0x1770
Input Instance 155 (OK)	1, 0	0	0	0	0	0	0	0	0	0	0	0	0	0	0	0	0	0x0000
	3, 2	0	0	0	0	0	0	0	0	0	0	0	1	1	0	0	0	0x0018
	5, 4	0	0	0	1	0	1	1	1	0	1	1	1	0	0	0	0	0x1770
Input Instance 155 (NG) (Error code *)	1, 0	0	1	0	0	0	0	0	0	0	0	0	0	0	0	0	0	0x4000
	3, 2	0	0	0	0	0	0	0	0	0	0	0	1	1	0	0	0	0x0018
	5, 4	0	0	0	0	0	0	0	0	0	0	0	0	0	0	0	1	0x0001

*Data of "Error code"
0x0001: Error

6. About EDS file

As for acquisition of an EDS file for VF-MB1 and VF-S15, please contact your Toshiba distributor.

7. Integration in RSLogix™

VF-MB1/S15 drive equipped with an EtherNet/IP module shall be configured as a "Generic Ethernet Module."

RSLogix™ is a trademark of Rockwell Automation, Inc.

7.1. Create a new project

Power on of PLC and launch the software of RSLogix™5000. (Set the key switch of PLC to "PROG" mode.)

Create a new project and configure the following contents.

The meaning of revision is revision of the program.

Select the your PLC

The slot is set to 0 in case of the leftmost slot.

7.2. Add a EtherNet/IP scanner to the I/O configuration

Right-click the I/O Configuration, and select “New Module”.

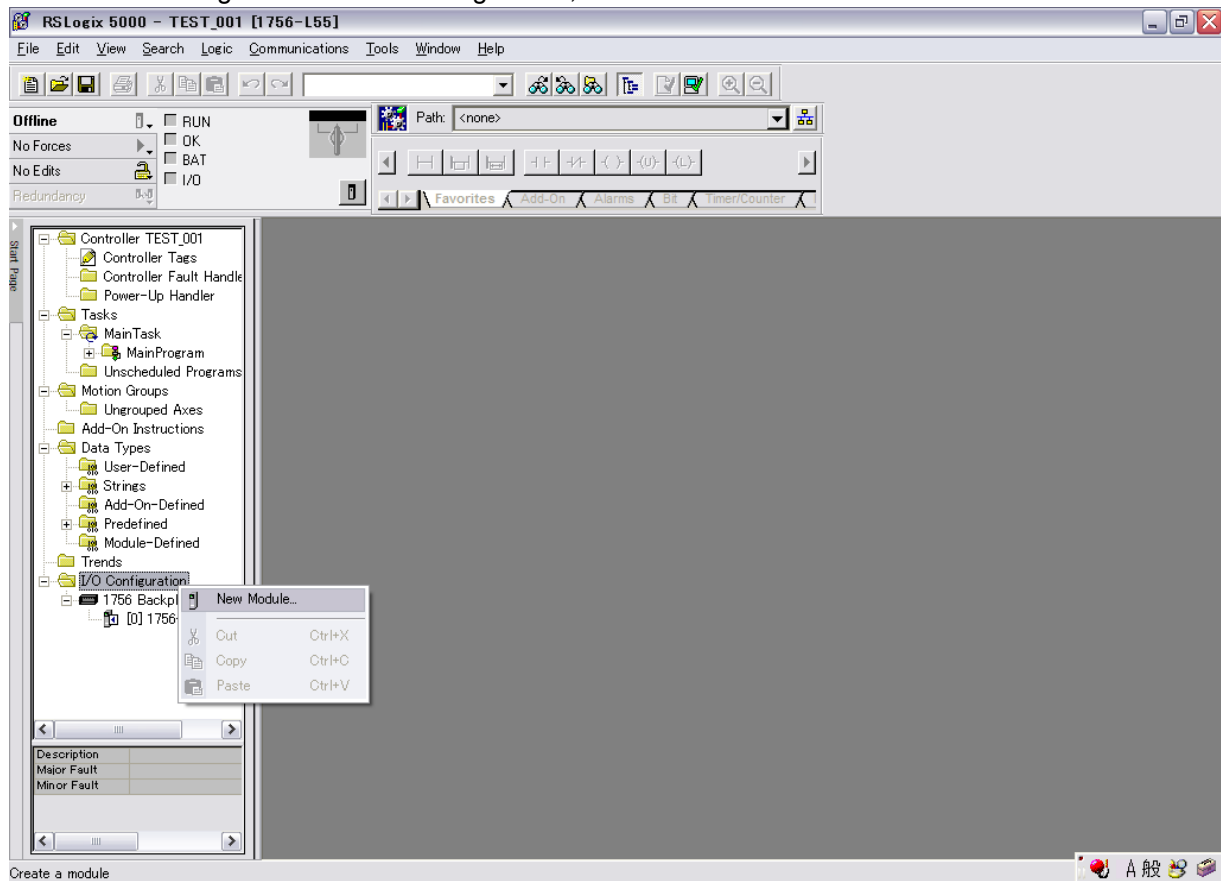

Click the “Communications” to expand “Communications” group.

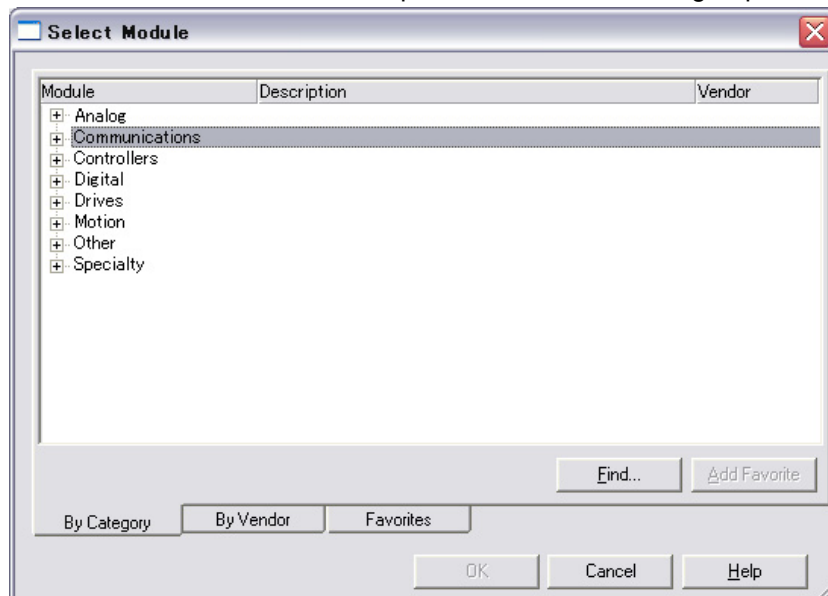

Select the Module as below.

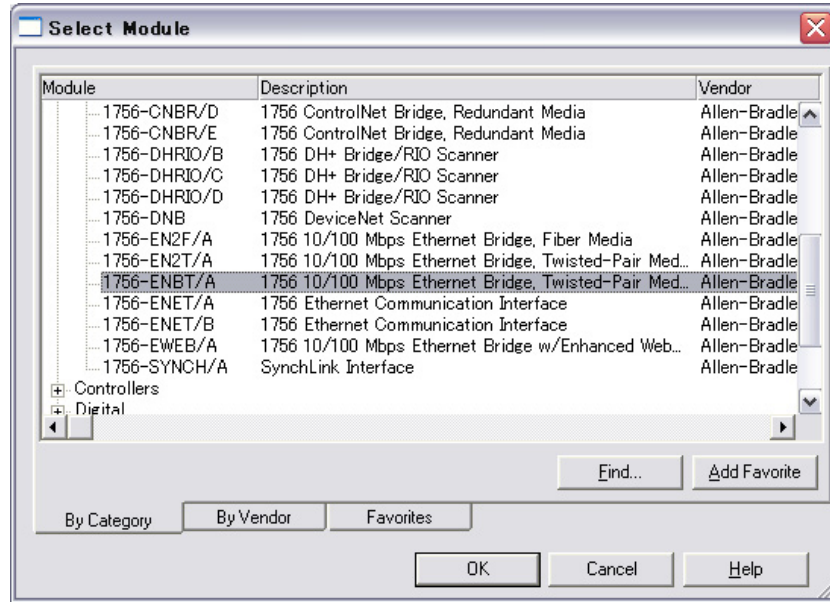

Select revision of drive.

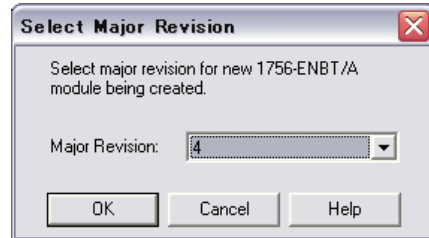

Put in Name and IP address, and press "OK" button.

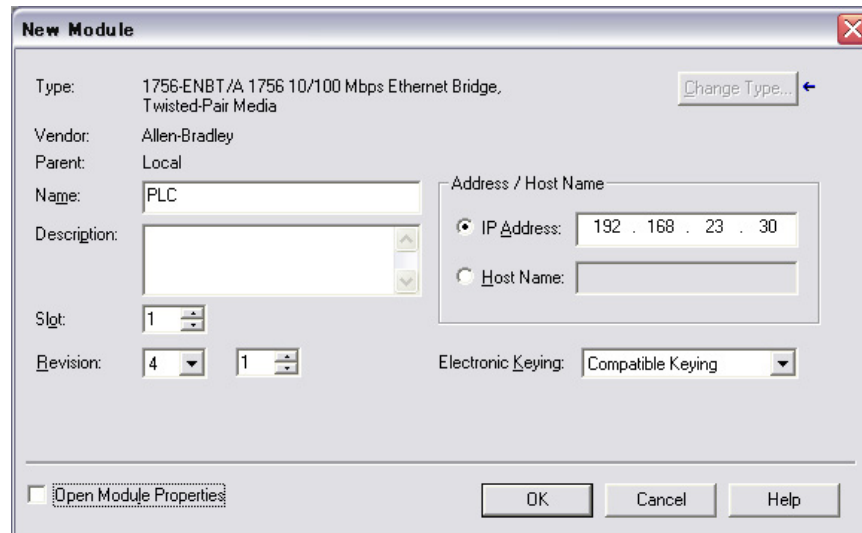

7.3. Configure the VF-MB1/S15 EtherNet/IP module

Right-click the EtherNet/IP scanner, and select “New Module”.

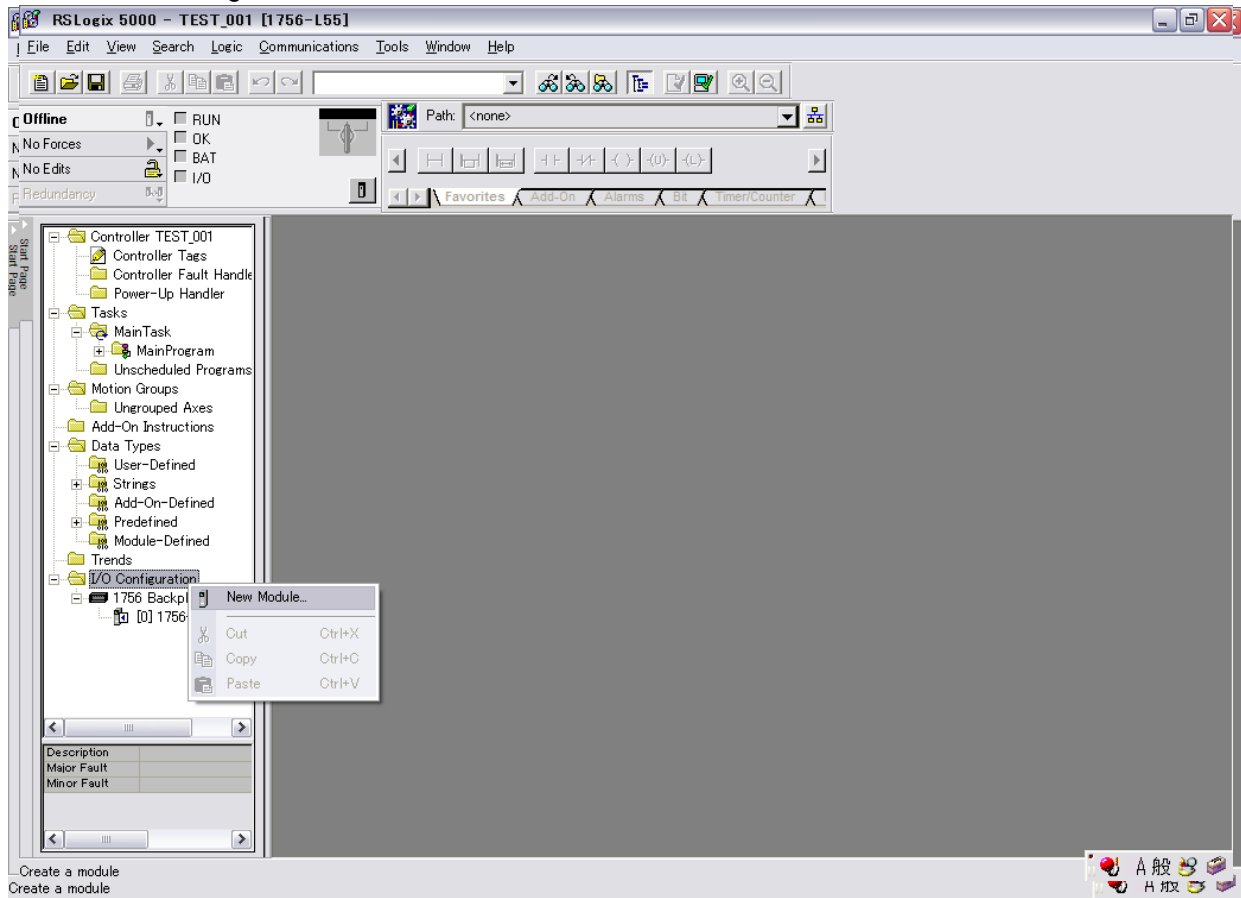

Click the “Communications” to expand “Communications” group.

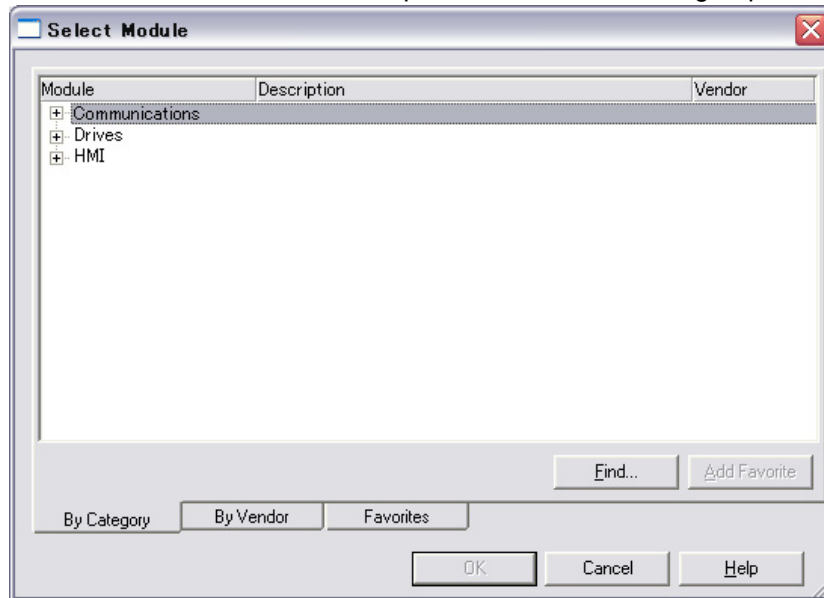

Above the Allen-Bradley drive profile is selected.

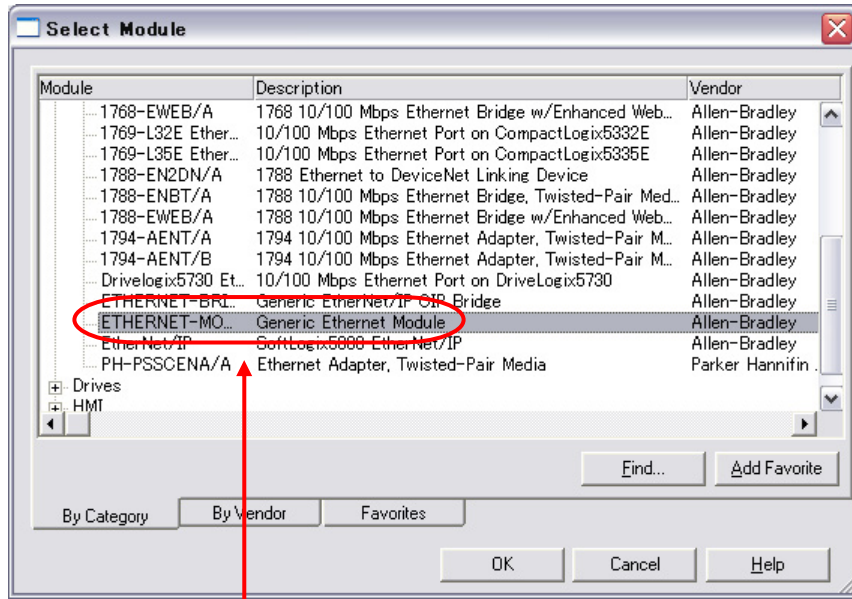

Select the format of the data.

Above the CIP basic speed control profile is selected.

7.4. Download the program to the PLC

The first download follows the following procedure.

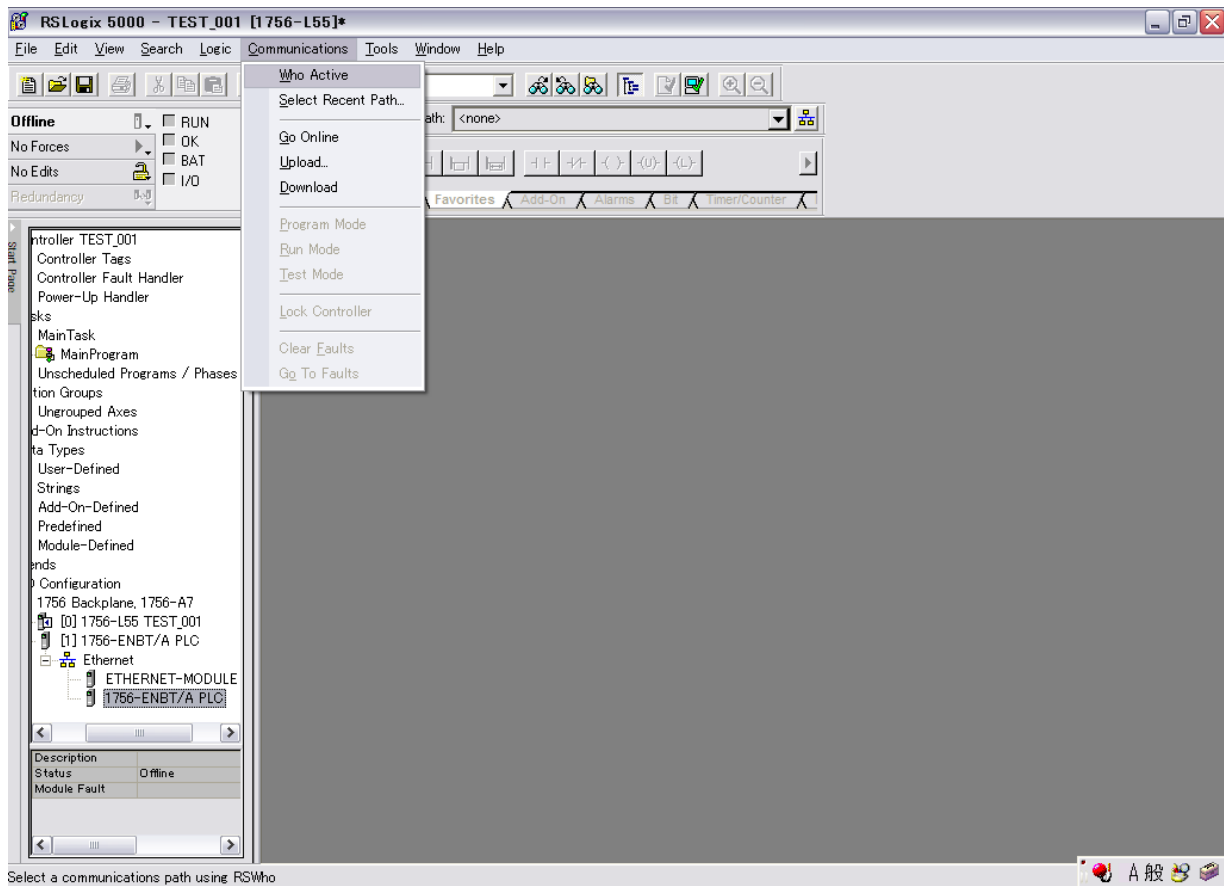

Select the using PLC.

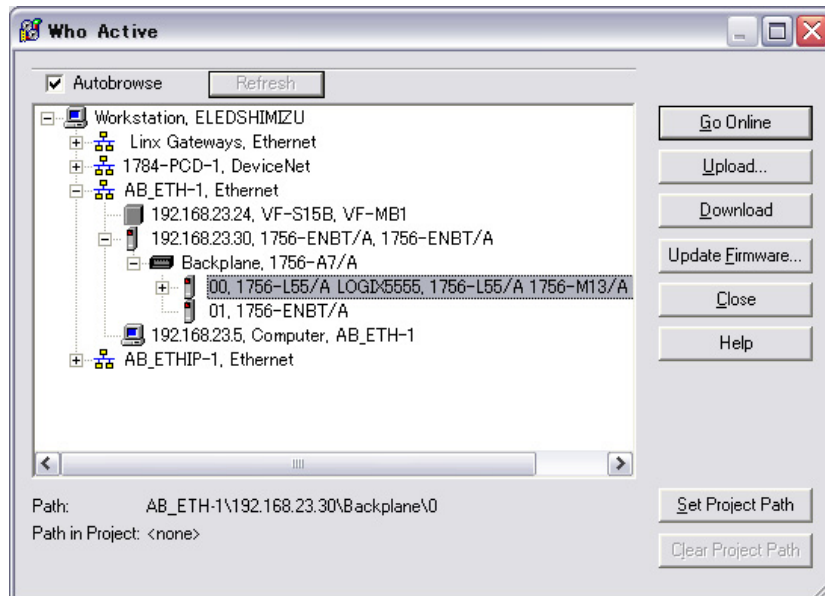

Select the "Download."

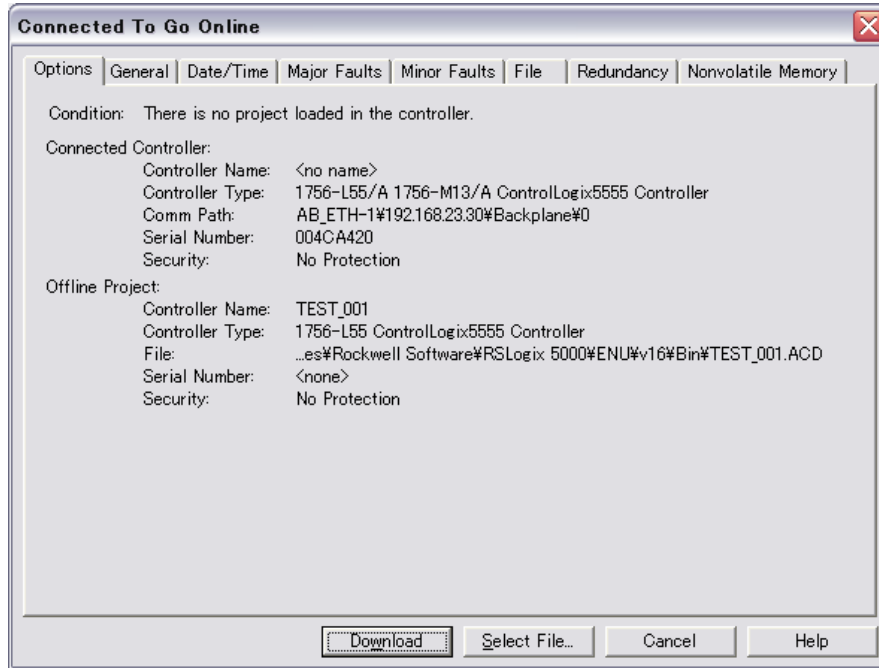

Once again, select the "Download."

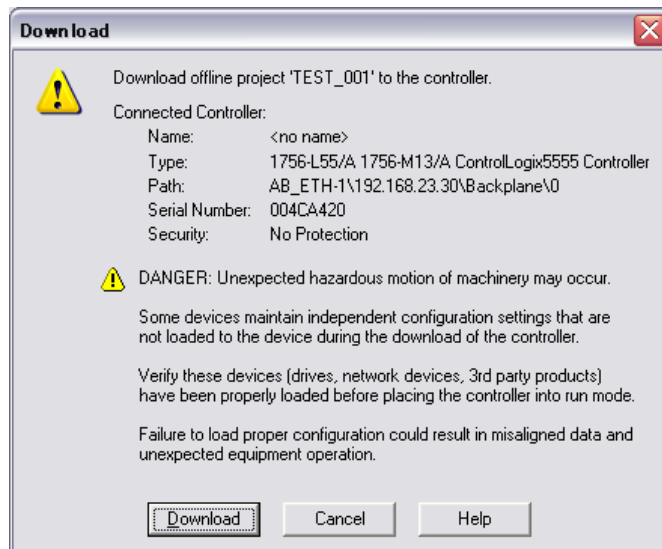

7.5. Edit the I/O scan data

Open the "Controller Tags."

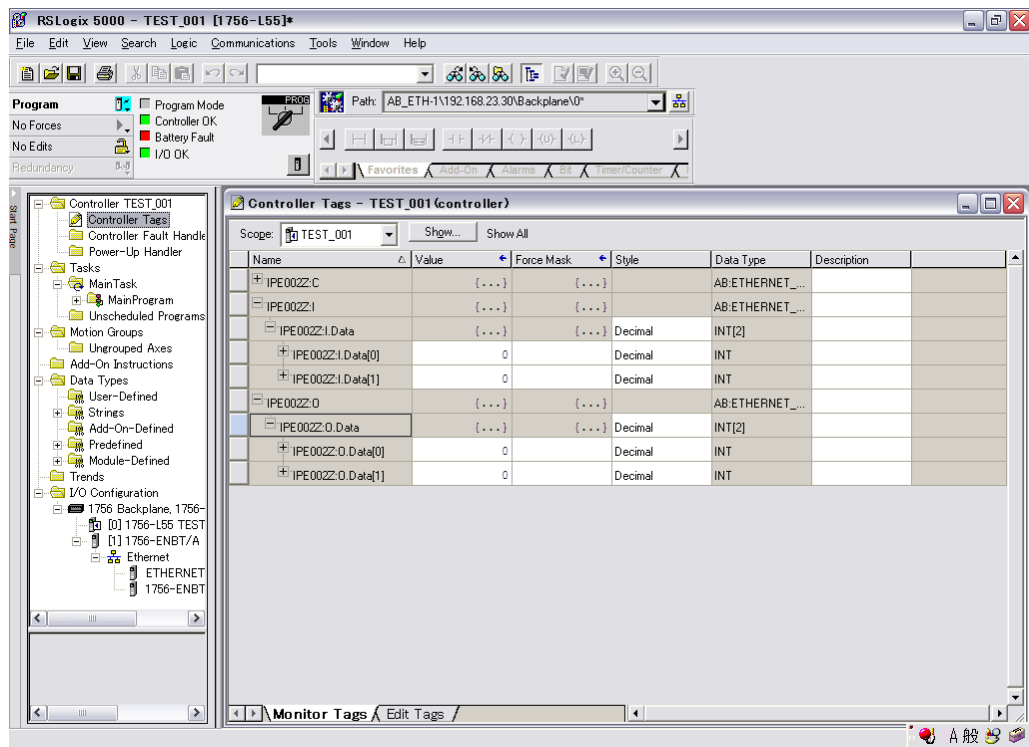

Set to the "Offline" if change the value and the type of data.

And, change by "Controller Tag" after "the SW of PLC is set to PROG".

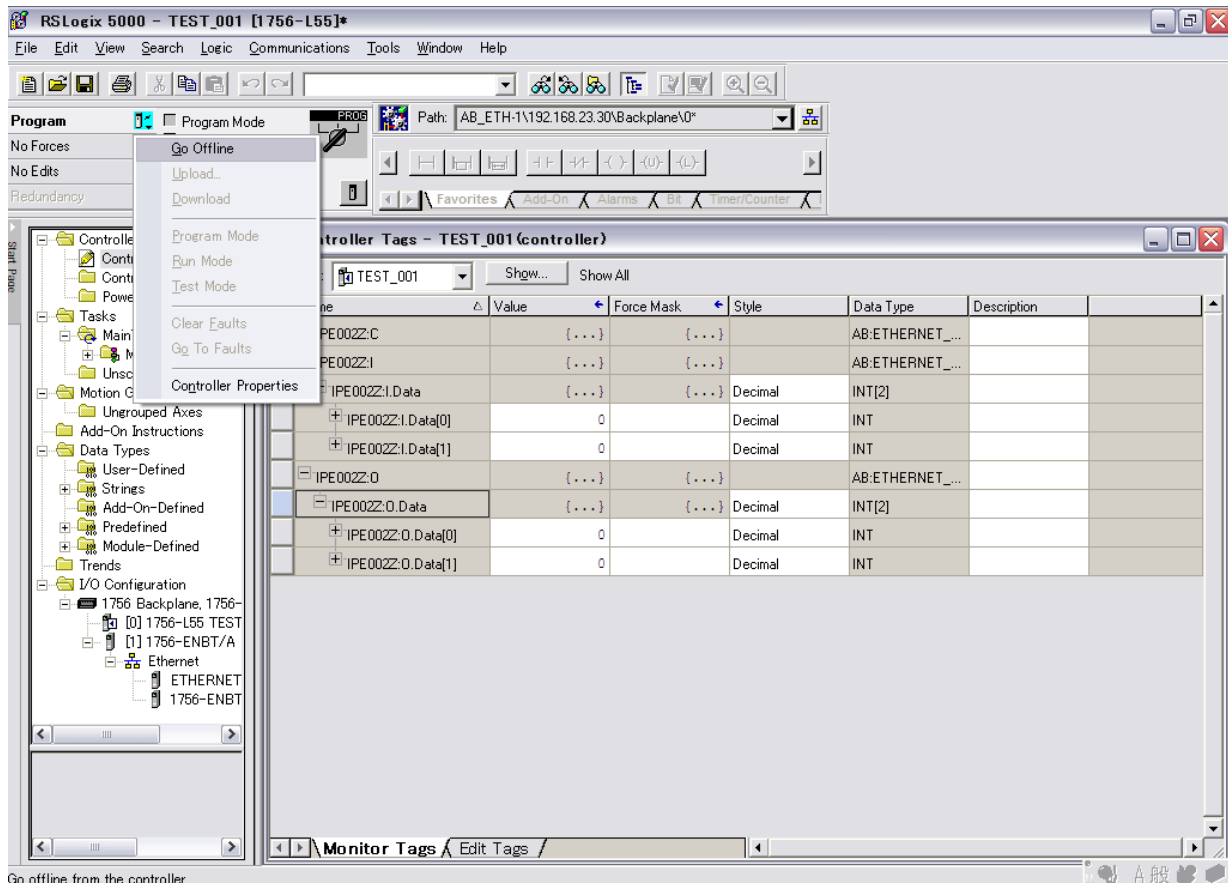

Go offline from the controller

Download the changed data to the PLC. : "Communications" → "Download"

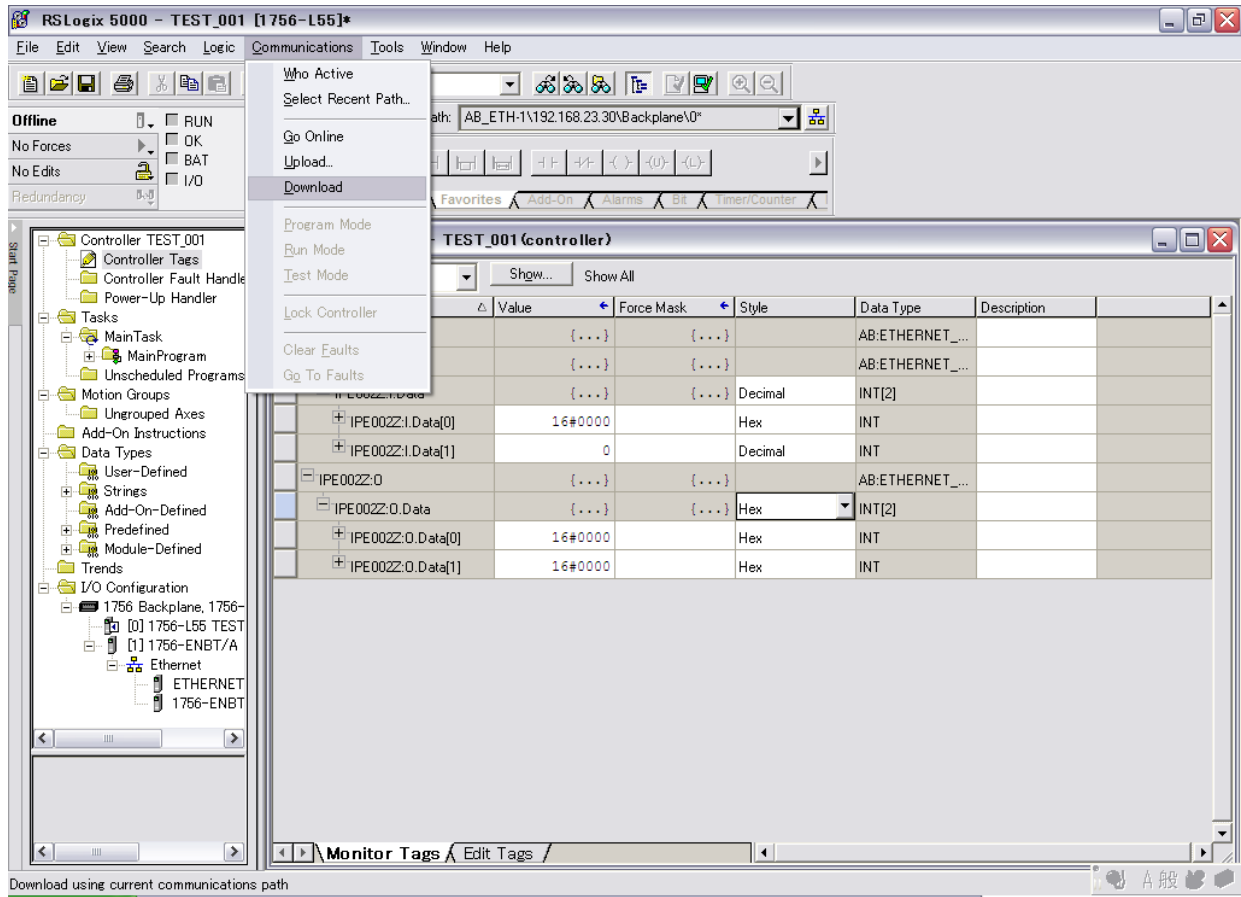

After the setting is downloaded, set to "RUN" the key SW of the PLC.

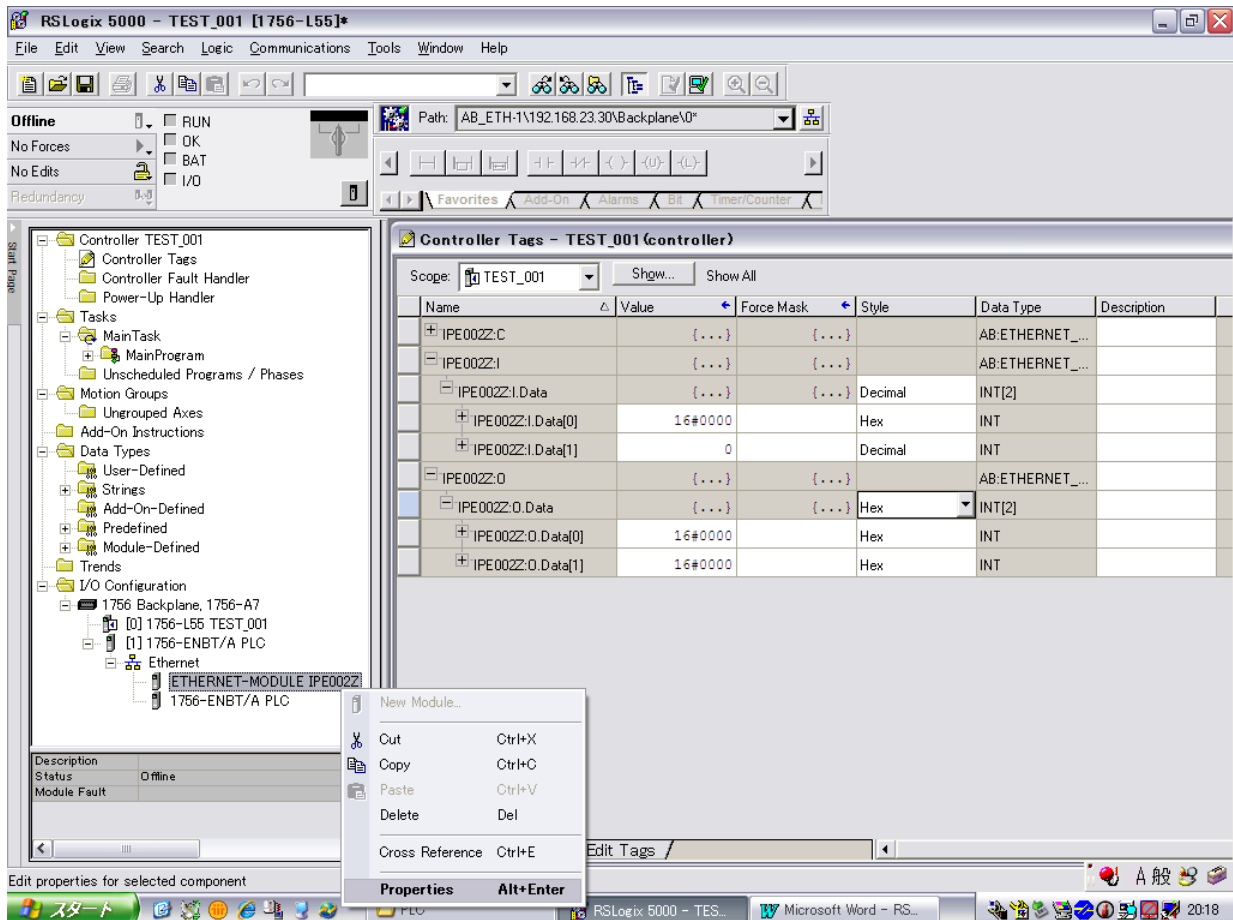

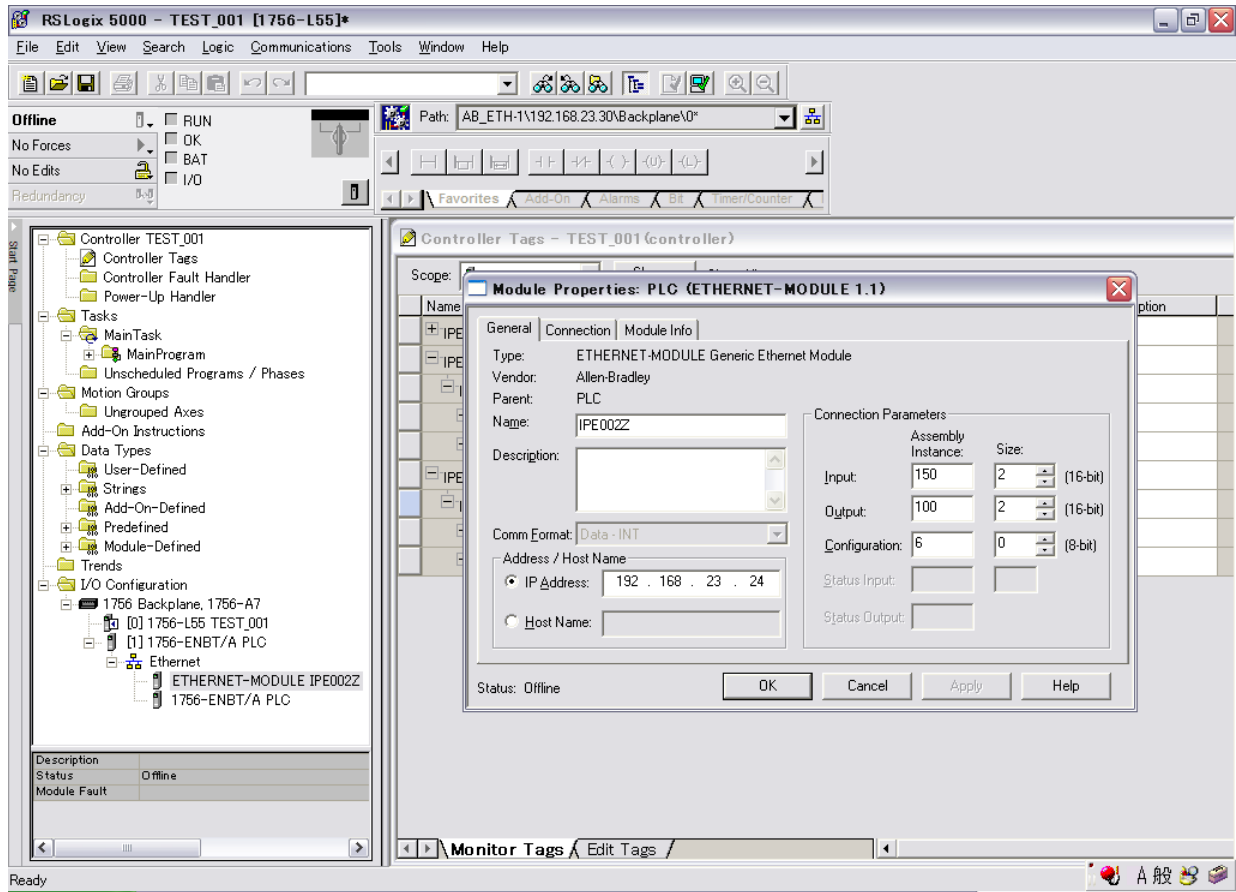

8. Modbus TCP server

8.1. Modbus TCP frames

Modbus TCP frames consist of a header and a Modbus request.

Header format:

Byte	Description		Comments
0	Transaction identifier	high order	This identifier always equals 0.
1		low order	
2	Protocol identifier	high order	
3		low order	
4	Length of data	high order	Number of bytes in the Modbus request +1. The frame length is always less than 256 bytes, the value of the significant byte therefore equals 0.
5		low order	
6	Destination identifier (Unit ID)		
7	Modbus request function code		

The frame header returned by the VF-MB1/S15 server is identical to that of the frame sent by the client.

8.2. Drive Modbus servers

The destination identifier (Unit ID) is used to access drive Modbus TCP servers:

Unit ID	Modbus TCP server	Accessible parameters
0-248	Variable speed drive	See the VF-MB1/VF-S15 instruction manual.
251	Option board	
255	IO Scanner	See the "IO Scanner" section.

8.3. List of Modbus functions supported

Function code	Modbus name	Description	Size of data
03	Read Holding Registers	Read N output words	63 words max.
06	Write Single Register	Write one output word	-
16 (0x10)	Write Multiple Registers	Write N output words	63 words max.
23 (0x17)	Read/Write Multiple Registers	Read/write N words (IO Scanning)	20/20 words max.
43 (0x2B)	Read Device Identification	Identification	-

8.4. "03 (0x03) Read Holding Registers" function

The Modbus request is used to read the values of a number (Number of Points) of adjacent words starting at the address indicated (Starting Address). The values read are restored one after another, at the end of the response (First Point Data -> Last Point Data).

Request Format:

Byte	Meaning
0	Function Code = 03h
1	Starting Address Hi
2	Starting Address Lo
3	Number of Points Hi (0)
4	Number of Points Lo (1 - 125)

Response format:

Byte	Meaning
0	Function Code = 03h
1	Byte Count (B = 2 × Number of Points)
2	First Point Data Hi
3	First Point Data Lo
...
B	Last Point Data Hi
B+1	Last Point Data Lo

Exception response format:

Byte	Meaning
0	Function Code = 83h
1	Exception Code = 01 (Illegal Function) 02 (Illegal Data Address) 03 (Illegal Data Value)

Notes

- ▼ If the communication number that doesn't exist is read, IPE002Z returns 0x8000.

8.5. "06 (0x06) Write Single Register" function

This Modbus request is used to write a given value (Present Data) to the address supplied (Register Address).

Request format:

Byte	Meaning
0	Function Code = 06h
1	Register Address Hi
2	Register Address Lo
3	Preset Data Hi
4	Preset Data Lo

Response format:

Byte	Meaning
0	Function Code = 06h
1	Register Address Hi
2	Register Address Lo
3	Preset Data Hi
4	Preset Data Lo

Exception response format:

Byte	Meaning
0	Function Code = 86h
1	Exception Code = 01 (Illegal Function) 02 (Illegal Data Address) 03 (Illegal Data Value) 04 (Slave Device Failure)

Note: If error is occurred at writing the parameter of inverter, "02" is returned as Exception code.

Notes

- ▼ As for the EEPROM parameter, first the data is written to RAM, after that the data is written to EEPROM. Some EEPROM parameters cannot be changed during the inverter is running. When write to EEPROM parameter that will change inverter status from stop to run, the inverter must be in the state that it cannot run. For example: To write to EEPROM, the inverter must open ST-CC. (display shows "OFF") If not, the data is only written to RAM.
- ▼ The Life of EEPROM is approximately 100,000 times. Avoid writing a command more than 100,000 times to the same parameter of the Inverter.
- ▼ Please access only parameters in document.

8.6. "16 (0x10) Write Multiple Registers" function

This Modbus request is used to write a number (Number of Registers) of adjacent words starting at a given address (Starting Address). The values to be written are supplied one after another (First Register Data -> Last Register Data).

Request format:

Byte	Meaning
0	Function Code = 10h
1	Starting Address Hi
2	Starting Address Lo
3	Number of Registers Hi (0)
4	Number of Registers Lo (1 - 100)
5	Byte Count (B = 2 × Number of Registers)
6	First Register Data (Hi)
7	First Register Data (Lo)
...
B+4	Last Register Data (Hi)
B+5	Last Register Data (Lo)

Response format:

Byte	Meaning
0	Function Code = 10h
1	Starting Address Hi
2	Starting Address Lo
3	Number of Registers Hi (0)
4	Number of Registers Lo (1 - 100)

Exception response format:

Byte	Meaning
0	Function Code = 90h
1	Exception Code = 01 (Illegal Function) 02 (Illegal Data Address) 03 (Illegal Data Value) 04 (Slave Device Failure)

Note: If error is occurred at writing the parameter of inverter, "02" is returned as Exception code.

Notes

- ▼ As for the EEPROM parameter, first the data is written to RAM, after that the data is written to EEPROM. Some EEPROM parameters cannot be changed during the inverter is running. When write to EEPROM parameter that will change inverter status from stop to run, the inverter must be in the state that it cannot run. For example: To write to EEPROM, the inverter must open ST-CC. (display shows "OFF") If not, the data is only written to RAM.
- ▼ The Life of EEPROM is approximately 100,000 times. Avoid writing a command more than 100,000 times to the same parameter of the Inverter.
- ▼ Please access only parameters in document.

8.7. "23 (0x17) Read/Write Multiple Registers" function

The "Read/Write Multiple Registers" service is reserved for setting up the IO Scanning service (see "IO Scanning" section)

Request format:

Byte	Meaning
0	Function Code = 17h
1	Read Starting Address Hi (00)
2	Read Starting Address Lo (00)
3	Number of Read Registers Hi (0)
4	Number of Read Registers Lo (1 – 6)
5	Write Starting Address Hi (00)
6	Write Starting Address Lo (00)
7	Number of Write Registers Hi (00)
8	Number of Write Registers Lo (1 - 6)
9	Byte Count (B = 2 × Number of Write Registers)
10	First Write Register Data (Hi) (0)
11	First Write Register Data (Lo) (1-6)
...
B+8	Last Write Register Data (Hi)
B+9	Last Write Register Data (Lo)

Response format:

Byte	Meaning
0	Function Code = 17h
1	Byte Count (B = 2 × Number of Points)
2	First Point Data of Read Hi
3	First Point Data of Read Lo
...
B	Last Point Data of Read Hi
B+1	Last Point Data of Read Lo

Exception response format*:

Byte	Meaning
0	Function Code = 97h
1	Exception Code = 01 (Illegal Function) 02 (Illegal Data Address) 03 (Illegal Data Value) 04 (Slave Device Failure)

Note: If error is occurred at writing the parameter of inverter, "02" is returned as Exception code.

Notes

- ▼ If the communication number that doesn't exist is read, IPE002Z returns 0x8000.
- ▼ As for the EEPROM parameter, first the data is written to RAM, after that the data is written to EEPROM. Some EEPROM parameters cannot be changed during the inverter is running. When write to EEPROM parameter that will change inverter status from stop to run, the inverter must be in the state that it cannot run. For example: To write to EEPROM, the inverter must open ST-CC. (display shows "OFF") If not, the data is only written to RAM.
- ▼ The Life of EEPROM is approximately 100,000 times. Avoid writing a command more than 100,000 times to the same parameter of the Inverter.
- ▼ Please access only parameters in document.

8.8. "43 (0x2B) Read Device identification" function

The "Read/Write Multiple Registers" service is reserved for setting up the IO Scanning service (see "IO Scanning section").

Example in VF-MB1 is shown below.

Request format:

Byte	Meaning	
0	Function Code = 2Bh	2Bh
1	Type of MEI	0Eh
2	Read Device ID code	01: Basic 02: Regular 03: Extended
3	Object ID	0

Response format: (ID = 248)

Byte	Meaning	With the IPE002Z	
0	Function Code = 2Bh	2Bh	
1	Type of MEI	0Eh	
2	Read Device ID code	01: Basic 02: Regular 03: Extended	
3	Conformity Level	2	
4	More Follows	0	
5	Next Object Id	0	
6	Number Of Objects	3 for Basic. 6 for Regular or Extended	
7	Obj 0 Id → Vendor Name	0	
8	Obj 0 length	7	
9-15	Obj 0 value	"TOSHIBA"	
16	Obj 1 Id → ProductCode	1	
17	Obj 1 length	13	
18-30	Obj 1 value	"VFMB1S-2007PL"	
31	Obj 2 Id → Version	2	
32	Obj 2 length	5	
33-37	Obj 2 value	"10801"	
38	Obj 4 Id → Product Name	4	Only for Regular and Extended
39	Obj 4 length	6	
40-45	Obj 4 value	"VF-MB1"	
46	Obj 5 Id → Model Name	5	
47	Obj 5 length	3	
44-58	Obj 5 value	"TSB"	
59	Obj 6 Id → UserApplicationName	6	
60	Obj 6 length	16 maximum	
61-80	Obj 6 value	"ModbusTCP"	

Response format: (ID = 251)

Byte	Meaning	With the IPE002Z
0	Function Code = 2Bh	2Bh
1	Type of MEI	0Eh
2	Read Device ID code	01: Basic 02: Regular 03: Extended
3	Conformity Level	2
4	More Follows	0
5	Next Object Id	0
6	Number Of Objects	3 for Basic. 6 for Regular or Extended
7	Obj 0 Id → Vendor Name	0
8	Obj 0 length	7
9-15	Obj 0 value	"TOSHIBA"
16	Obj 1 Id → ProductCode	1
17	Obj 1 length	7
18-24	Obj 1 value	"IPE002Z"
25	Obj 2 Id → Version	2
26	Obj 2 length	4
27-30	Obj 2 value	"0106"

Exception response format:

Byte	Meaning
0	Function Code = ABh
1	Exception Code = 01 (Illegal Function) 02 (Illegal Data Address) 03 (Illegal Data Value)

8.9. Parameter data

It is explanation by the reference method of the list of parameters of the VF-MB1 or VF-S15 series as follows. For communication purpose, see the parameter list on inverter's instruction manual regarding the communication number, adjustment range and so forth.

<Example of excerpts from the inverter's instruction manual>

Title	Communication No.	Function	Adjustment range	Minimum setting unit (Panel/Communication)	Default setting	Write during running	Reference
RU H	-	History function	Displays parameters in groups of five in the reverse order to that in which their settings were changed.	1/1	-	-	4.3 5.1
RU F	0093	Guidance function	0 : - 1 : - 2 : Preset speed guidance 3 : Analog signal operation guidance ...	1/1	0	Disabled	4.3 5.2
RU L	0094	Overload characteristic selection	0 : - 1 : Constant torque characteristic (150%-60s) 2 : Variable torque characteristic (120%-60s) ...	1/1	-	Disabled	3.5 5.3 6.14
⋮	⋮	⋮	⋮	⋮	⋮	⋮	⋮
dE L	0010	Deceleration time 1	0.1 to 6000 sec.	0.1/0.1 *2	*1	Enabled	5.2
L Y P	0007	Factory default setting	0 : - 1 : 50 Hz default setting 2 : 60 Hz default setting 3 : Default setting 1 (Initialization) ...	1/1	-	Disabled	5.20
⋮	⋮	⋮	⋮	⋮	⋮	⋮	⋮

*1: Default values vary depending on the capacity.

*2: Changing the parameter L Y P enables to set to 0.01 sec. (adjustment range: 0.01 - 600.0 sec.).

- (1) "Title" means the display on the inverter panel.
- (2) "Communication number" is affixed to each parameter that is necessary for designating the parameter for communication.
- (3) "Adjustment range" means a data range adjustable for a parameter, and the data cannot be written outside the range. The data have been expressed in the decimal notation. For writing the data through the communication function, take the minimum setting unit into consideration, and use hexadecimal system.
- (4) "Minimum setup unit" is the unit of a single data (when the minimum unit is "-", 1 is equal to 1). For example, the "minimum setup unit" of acceleration time (R L L) is 0.01, and 1 is equal to 0.01s. For setting a data to 10 seconds, transmit 0x03E8 [$10 \div 0.01 = 1000d = 0x03E8$] by communication.
- (5) Communication numbers "0xxxxA" to "0xxxxF" don't exist in VF-MB1 or VF-S15. Therefore, these communication numbers are skipped when read or write. For example:
When the data of two words is read from R L L (0009h), 0x000A doesn't exist because of this specification.
Consequently, in this case ACC(0009h) and DEC(0010h) are read.

9.IO Scanning service

9.1. Presentation

The IO Scanning service is used to exchange I/O data between:

- A controller or PLC (IO Scanner).
- Devices (IO Scanning servers).

This exchange is usually performed by implicit services, thus avoiding the need to program the controller (PLC).

The IO Scanner periodically generates the Read/Write Multiple Registers (23 = 0x17) request.

The IO Scanning service operates if it has been enabled in the PLC and the drive.

The drive parameters assigned to IO Scanning have been selected by default. This assignment can be modified by configuration.

The drive IO Scanning service can also be configured by the option Modbus server.

When the IO Scanning service has been enabled in the VF-MB1/S15 drive:

- A TCP connection is assigned to it.
- The parameters assigned in the periodic variables are exchanged cyclically between the option and the drive.
- The parameters assigned in the periodic output variables are reserved for IO Scanning. They cannot be written by another Modbus service, even if the IO Scanner is not sending its periodic output variables.

9.2. Periodic variables

Word No.	Output variables (written by IO Scanner)	Input variables (read by IO Scanner)
0	Reserved	Reserved
1	Scanner write word 1 – configurable (C001)	Scanner read word 1 – configurable (C021)
2	Scanner write word 2 – configurable (C002)	Scanner read word 2 – configurable (C022)
3	Scanner write word 3 – configurable (C003)	Scanner read word 3 – configurable (C023)
4	Scanner write word 4 – configurable (C004)	Scanner read word 4 – configurable (C024)
5	Scanner write word 5 – configurable (C005)	Scanner read word 5 – configurable (C025)
6	Scanner write word 6 – configurable (C006)	Scanner read word 6 – configurable (C026)
7-31	Reserved	Reserved

It is possible to configure the assignment of periodic variables 1 to 6.

Please refer to "parameter" about configurable.

10. Example of the setup with PL7™

It is an example of the setup using PLC (PL7™) made by Schneider electric as follows.

10.1. Defining the hardware configuration

Configure an Ethernet module then configure the module so that it can communicate with the drive. The example shows a TSX Premium PLC equipped with a TSX ETY5102 module.

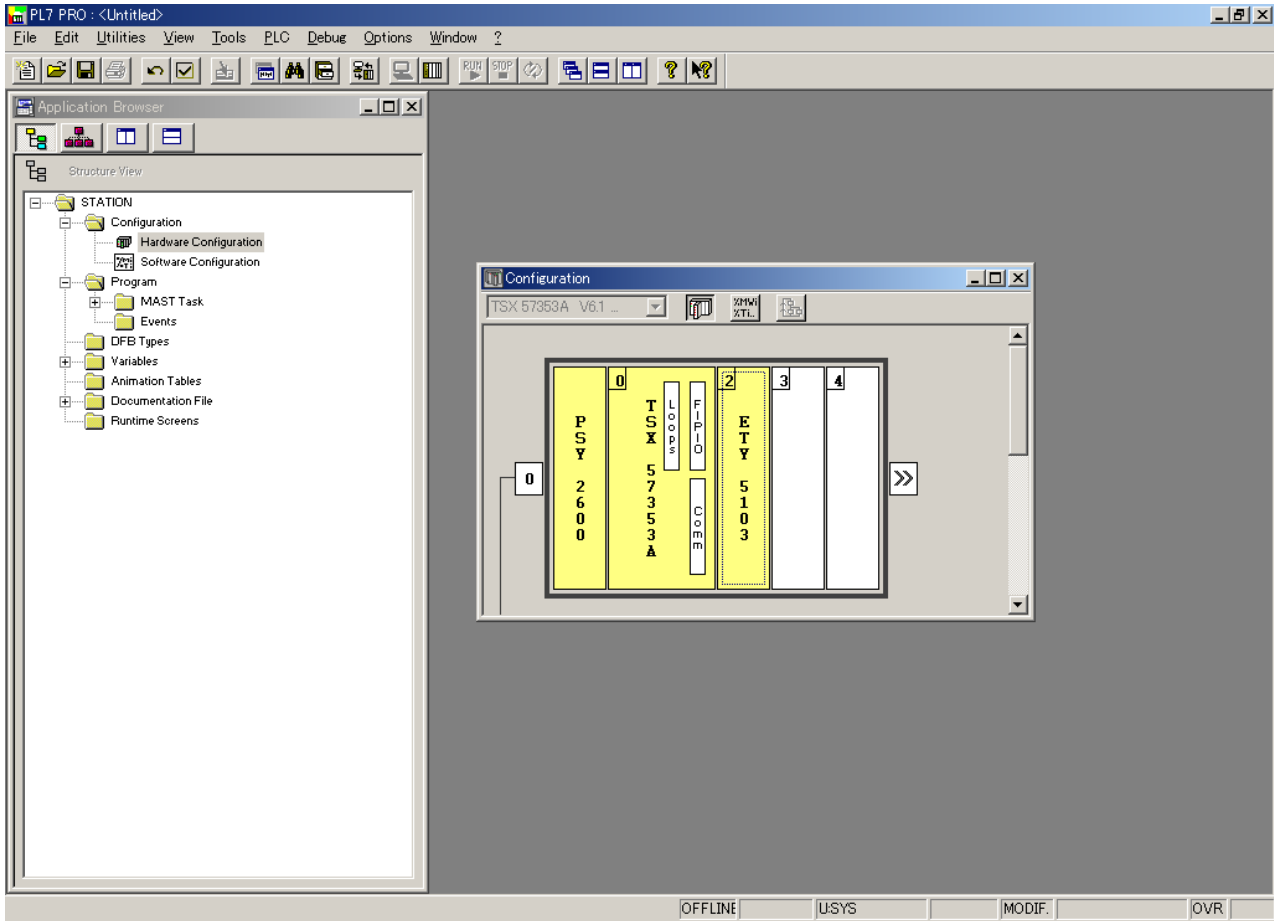

*PL7 is a trademark of Schneider Electric.

10.2. BOOTP configuration

The BOOTP server function consists of allocating BOOTP clients their IP addresses. The activation conditions for the drive BOOTP client are described in the “Configuration - IP Addresses” section.

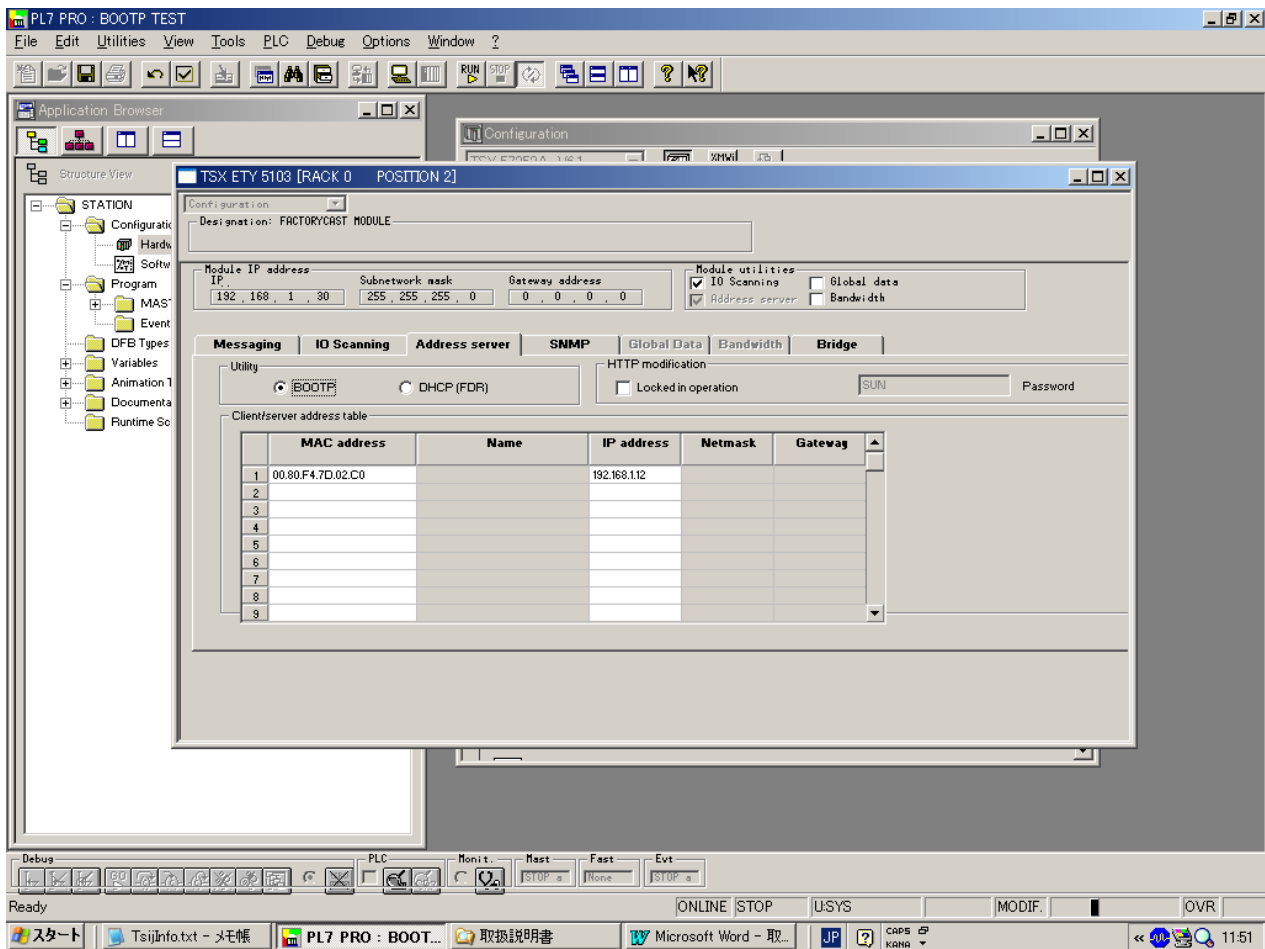

This window is used to configure the BOOTP server.

The drive MAC address is given on a label attached to its IPE002Z option module. The IP address assigned to the drive must be entered in the table against the MAC address.

In this example, the Ethernet module MAC address is 00.80.F4.7D.02.C0, and its IP address is 192.168.1.12.

Each line in the “Table of supplied addresses” can accept both the MAC and IP addresses of a BOOTP client.

10.3. Configuring Modbus messaging

To use Modbus messaging in PL7, the “IP address”, “Subnet mask” and “Gateway address” parameters must be configured in the “Messaging” tab in the PLC Ethernet module configuration screen.

Data entered in the “Connection configuration” box is used to manage the PLC Modbus messaging service, but has no effect on IO Scanning which is an independent service.

Example:

PLC IP address	192.168.1.30
Subnet mask	255.255.255.0
Gateway address	0.0.0.0
Drive IP address	192.168.1.12

	Xway address	IP address	Protocol	Access	Mode
1	1,101	192.168.1.12	MODBUS	<input checked="" type="checkbox"/>	MULTI

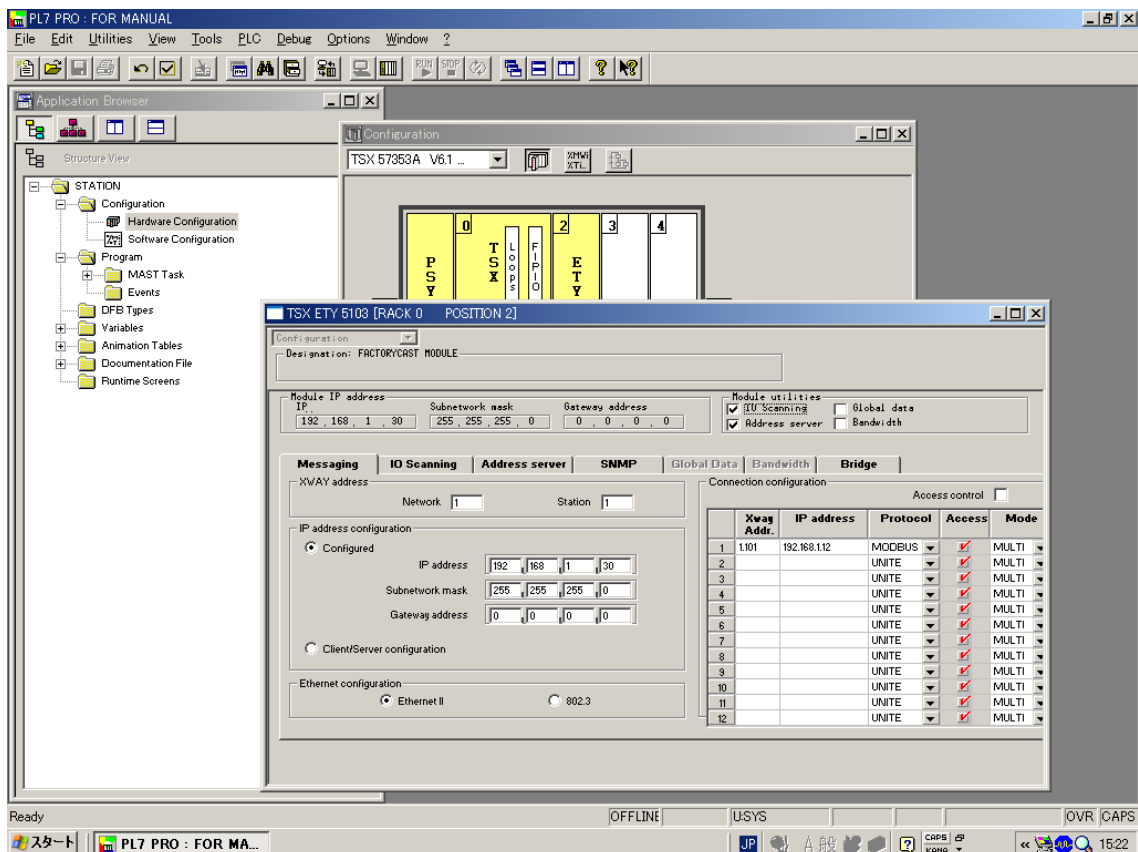

10.4. Configuring periodic variables

This window is used to configure the IO Scanning function, described in the IO Scanning Service section on page 72.

Example:

- The periodic variables of the drive at IP address 192.168.1.12 are associated with PLC data words.
- The drive periodic output variables (control) are associated with the 32 words (WR count) starting at PLC address %MW550 (Write Ref.).
- The drive periodic input variables (monitoring) are associated with the 32 words (RD count) starting at PLC address %MW500 (Read Ref.).

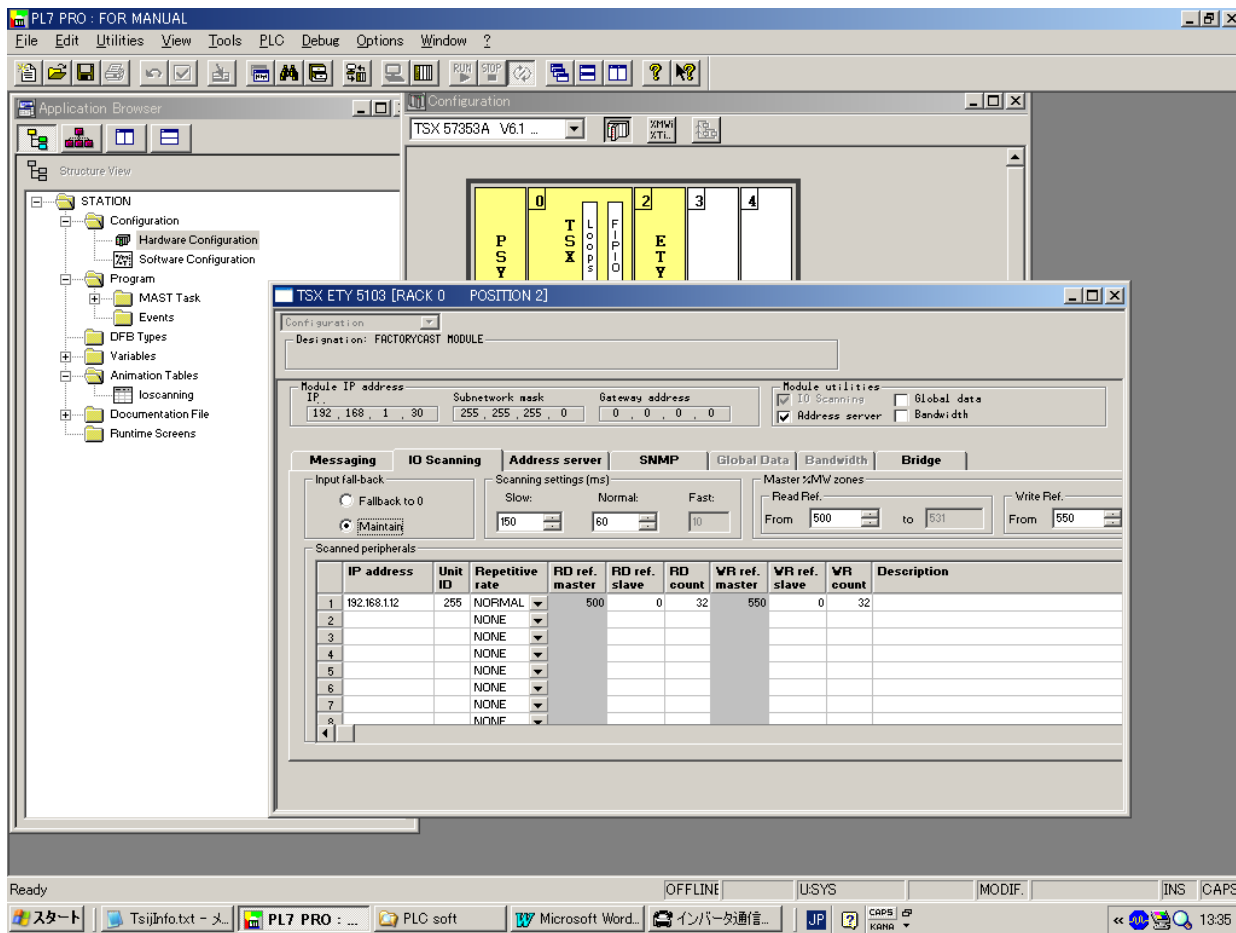

The addresses for the PLC %MW words correspond to the configuration in the previous example.

PLC address	Periodic output variable (default assignment)	Configurable
%MW 550	Reserved	No
%MW 551	Scanner write word 1	Yes (L001)
%MW 552	Scanner write word 2	Yes (L002)
%MW 553	Scanner write word 3	Yes (L003)
%MW 554	Scanner write word 4	Yes (L004)
%MW 555	Scanner write word 5	Yes (L005)
%MW 556	Scanner write word 6	Yes (L006)
%MW 557 to %MW 581	Reserved	No

PLC address	Periodic output variable (default assignment)	Configurable
%MW 500	Reserved	No
%MW 501	Scanner read word 1	Yes (L021)
%MW 502	Scanner read word 2	Yes (L022)
%MW 503	Scanner read word 3	Yes (L023)
%MW 504	Scanner read word 4	Yes (L024)
%MW 505	Scanner read word 5	Yes (L025)
%MW 506	Scanner read word 6	Yes (L026)
%MW 507 to %MW 531	Reserved	No

11. Command & Setpoint selection (Local/Remote)

Indication to display Local/Remote mode is on the inverter unit (Refer to the inverter instruction manual for details). EtherNet/IP™ - Modbus® TCP option command and setpoint are activated on Remote mode.

Inverters have some switches to select the command and setpoint location. Following figure shows the diagram. Refer to the inverter instruction manual for the parameter in detail.

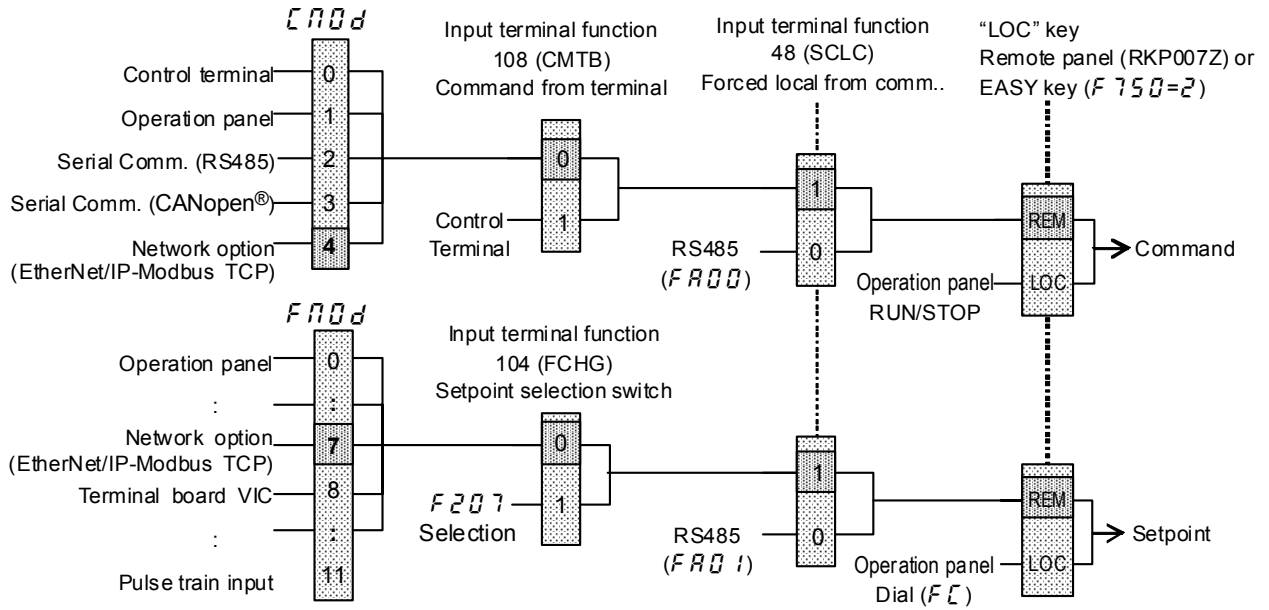

<Example of setting>

The example below shows how to configure the local/remote operation.

- F terminal Operating command
- R terminal EtherNet/IP-Modbus TCP local/remote
(Terminal in this example) switching
- VIA terminal Operation frequency command

<Wiring>

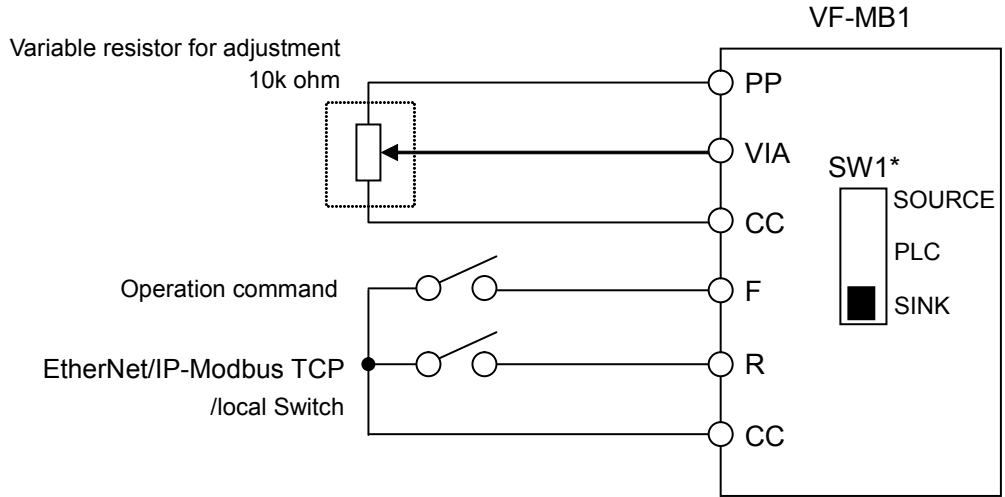

<Parameter setting>

- $\text{P}004$ (Command mode selection) = 0 (Terminal board)
- $\text{P}004$ (Frequency setting mode selection 1) = 1 (VIA)
- $\text{P}112$ (Input terminal selection 2 (R)) = 48 (Remote/Local control)

<Operation>

R-CC terminal open: VF-MB1 is controlled as a slave device of the EtherNet/IP™ - Modbus® TCP.

R-CC terminal closed:

- F-CC terminal short to RUN
- F-CC terminal open to STOP
- Output frequency is set up by the VIA signal input.

(Note)

When the local(HAND) / remote key ($\text{F}150=2$) is chosen as EASY key selection and the EASY key lamp of an inverter front panel is on, priority is most given to operation by a panel. (Refer to the inverter instruction manual for details).

12. Unusual diagnosis

12.1. Option error

An error message is displayed when the hardware error or software error or lose of connection of wire is occurred.

When an option and a combination of the inverter are bad, it is displayed.

■Display of trip information

$\text{E} - \text{23}$ (Error code : 55) : Optional unit fault 2

12.2. Disconnection error of network cable

When network trouble occurred by disconnection etc, the inverter does emergency stop with the following indication when the network disconnection detection ($\text{C} 100, \text{C} 523$) is set, and it was set in ($\text{C} 101=4$).

■Display of trip information

$\text{E} \text{r} \text{r} \text{B}$ (Error code: 27): Optional unit fault 1 (Communication error)

13. WebServer

The option has webserver function. Writing and reading the drive's parameter and the communication can be monitored by using this function through web network.

The chapter describes the function of the integrated webserver of the EtherNet/IP™ - Modbus® TCP module.

13.1. Access to the webserver

This web server can be accessed by the navigators listed below:

- Microsoft® Internet Explorer – Version 5.0 or greater

The navigator must support Java™ Virtual Machine because the factory loaded web server uses applets.

NOTE: As a TOSHIBA product, The EtherNet/IP™ option module uses internally Modbus® TCP for the webserver. (The Modbus® TCP port is not accessible.)

Startup the web browser and input IP address of the drive as the homepage address.

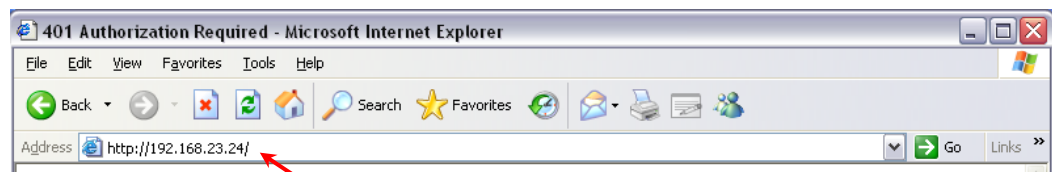

The drive IP address

From your web browser, default http password and login are “USER”.



From the TOSVERT home page, you can access to 3 main menus:

- Monitoring
- Network setup
- Diagnostics

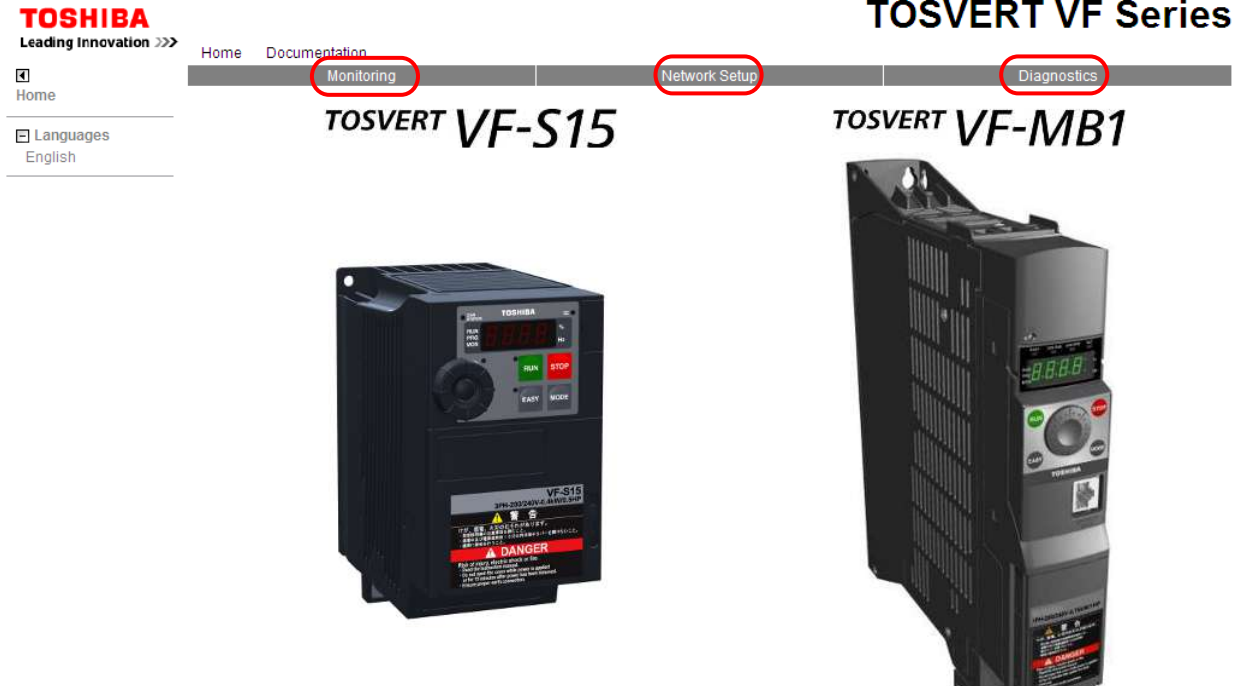

13.2. Web pages structure

Each web page uses the same structure. Each main menu, "Monitoring", "Network Setup" and "Diagnostics" contains each own sub menu. This last one is displayed on the left side of web page.

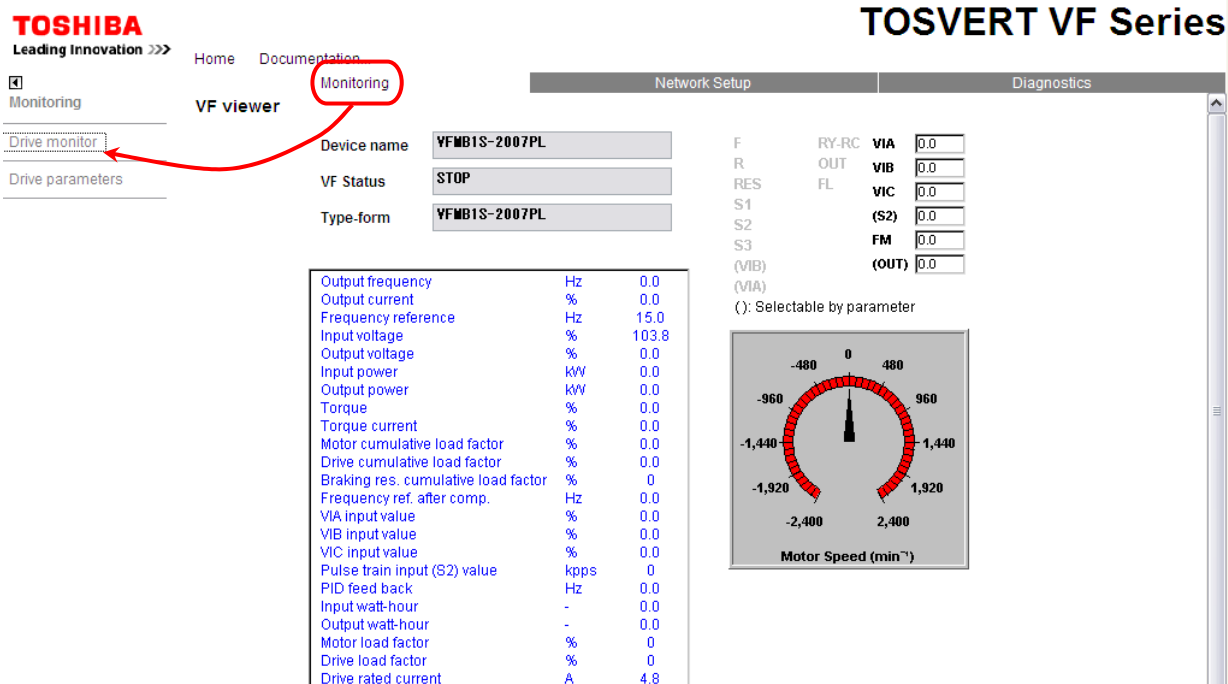

The button shows or hides the left sided menu.

13.3. Drive monitor (Main menu: Monitoring)

The state of the drive can be confirmed on this page.

TOSHIBA
Leading Innovation >>>

Home Documentation...

Monitoring

VF viewer

Drive monitor

Drive parameters

TOSVERT VF Series

Network Setup Diagnostics

Device name: **VFMB1S-2007PL**

VF Status: **STOP**

Type-form: **VFMB1S-2007PL**

Output frequency	Hz	0.0
Output current	%	0.0
Frequency reference	Hz	15.0
Input voltage	%	103.8
Output voltage	%	0.0
Input power	kW	0.0
Output power	kW	0.0
Torque	%	0.0
Torque current	%	0.0
Motor cumulative load factor	%	0.0
Drive cumulative load factor	%	0.0
Braking res. cumulative load factor	%	0
Frequency ref. after comp.	Hz	0.0
VIA input value	%	0.0
VIB input value	%	0.0
VIC input value	%	0.0
Pulse train input (S2) value	kpps	0
PID feed back	Hz	0.0
Input watt-hour	-	0.0
Output watt-hour	-	0.0
Motor load factor	%	0
Drive load factor	%	0
Drive rated current	A	4.8

F	RY-RC	VIA	0.0
R	OUT	VIB	0.0
RES	FL	VIC	0.0
S1		(S2)	0.0
S2		FM	0.0
S3		(OUT)	0.0

(VIB)
(VIA)
(.): Selectable by parameter

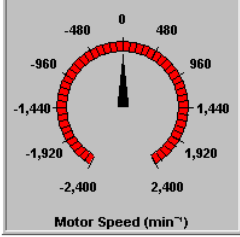

Motor Speed (min⁻¹)

13.4. Drive parameters (Main menu: Monitoring)

The parameters of the drive can be set on this page.

The left column is used to select a modify group (or list) of parameters. The right column displays the parameters, its Modbus address and its current value.

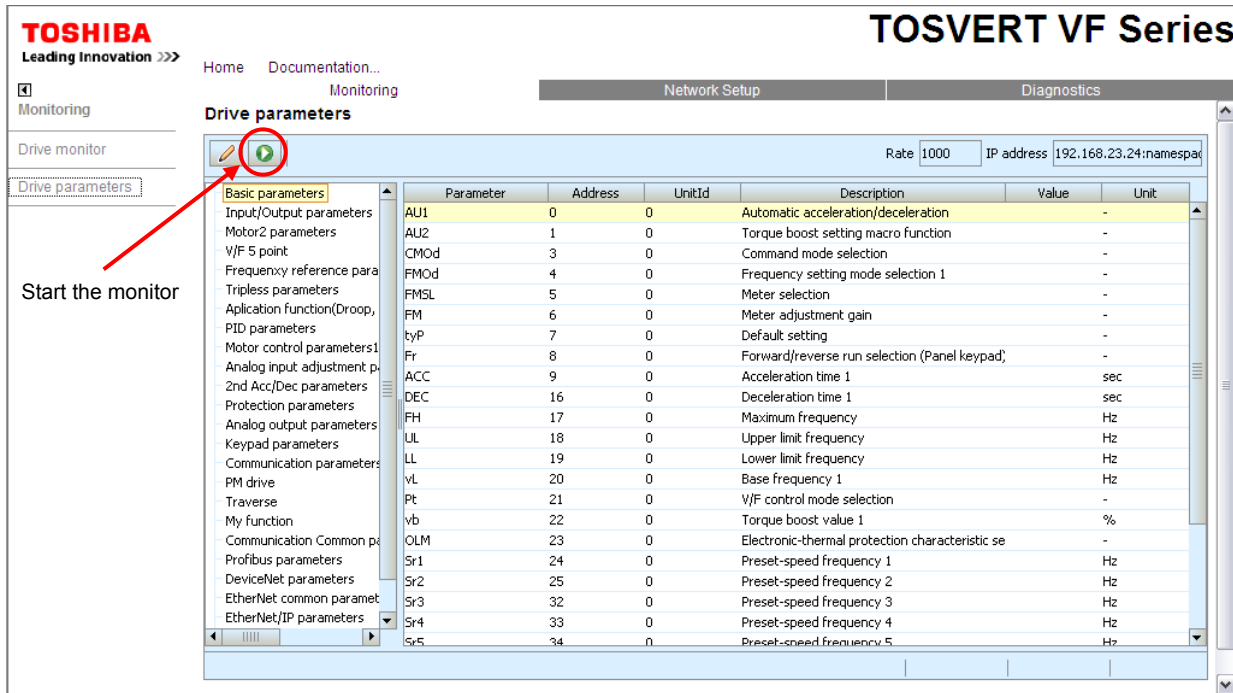

■ Set the parameters

When parameters of the drive are modified from the webserver, you need to input the PASSWORD. (The default password is "USER.")

It is necessary to be monitoring it to change the parameter.

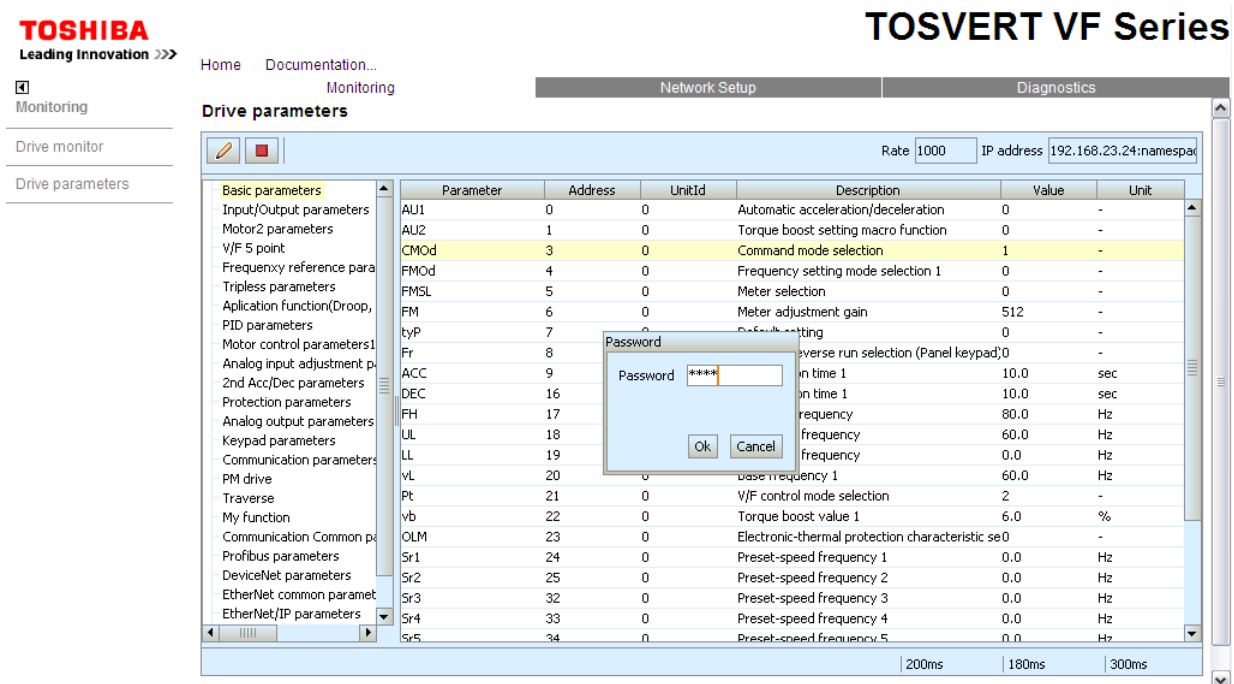

Input the write value to popup window.

TOSHIBA
Leading Innovation >>>

Home Documentation...
Monitoring

Monitoring

Drive monitor

Drive parameters

TOSVERT VF Series

Network Setup Diagnostics

Rate 1000 IP address 192.168.23.24.namespa

Drive parameters

Parameter	Address	UnitId	Description	Value	Unit
Basic parameters					
Input/Output parameters	AU1	0	Automatic acceleration/deceleration	0	-
Motor2 parameters	AU2	1	Torque boost setting macro function	0	-
V/F 5 point	CMod	3	Command mode selection	1	-
Frequency reference para	FMod	4	Frequency setting mode selection 1	0	-
Tripless parameters	FMSL	5	Meter selection	0	-
Application function(Droop,	FM	6	Meter adjustment gain	512	-
PID parameters	tyP	7			
Motor control parameters1	Fr	8	reverse run selection (Panel keypad)	0	-
Analog input adjustment p	ACC	9	n time 1	10.0	sec
2nd Acc/Dec parameters	DEC	16	n time 1	10.0	sec
Protection parameters	FH	17	frequency	80.0	Hz
Analog output parameters	UL	18	frequency	60.0	Hz
Keypad parameters	LL	19	frequency	0.0	Hz
Communication parameters	vL	20	frequency 1	60.0	Hz
PM drive	Pt	21	V/F control mode selection	2	-
Traverse	vb	22	Torque boost value 1	6.0	%
My function	OLM	23	Electronic thermal protection characteristic se0		-
Communication Common p	Sr1	24	Preset-speed frequency 1	0.0	Hz
Profibus parameters	Sr2	25	Preset-speed frequency 2	0.0	Hz
DeviceNet parameters	Sr3	32	Preset-speed frequency 3	0.0	Hz
EtherNet common paramet	Sr4	33	Preset-speed frequency 4	0.0	Hz
EtherNet/IP parameters	Sr5	34	Preset-speed frequency 5	0.0	Hz

220ms 180ms 601ms

write value

new value

Ok Cancel

13.5. Network parameters (Main menu: Network Setup)

The network parameters of the drive can be confirmed on this page.

When network parameters of the drive are modified from the webserver, you need to input the PASSWORD. (The default password is "USER.")

13.6. Modbus scanner (Main menu: Network Setup)

The I/O scanner of the Modbus[®] TCP protocol can be set on this page.

	Config	Value	Description		Config	Value	Description
1	FA06	1	Communication c...	1	FD01	1	Inverter status
2	FA07	3	Frequency comman...	2	FD00	2	Output frequenc...
3	-.0.	0	Not assigned	3	-.0.	0	Not assigned
4	-.0.	0	Not assigned	4	-.0.	0	Not assigned
5	-.0.	0	Not assigned	5	-.0.	0	Not assigned
6	-.0.	0	Not assigned	6	-.0.	0	Not assigned

When I/O scanner of the Modbus[®] TCP protocol are modified from the webserver, input the PASSWORD. (The default password is "USER.")

13.7. EthIP scanner (Main menu: Network Setup)

The I/O scanner of the EtherNet/IP protocol can be set on this page.

TOSHIBA
Leading Innovation >>>

Home Documentation...
Monitoring Network Setup Diagnostics

EtherNet/IP Scanner configuration

EtherNet/IP Scanner configuration

Assembly 102				Assembly 152			
	Config	Value	Description		Config	Value	Description
1	FA06	1	Communication ci	1	FD01	1	Inverter status
2	FA07	3	Frequency commai	2	FD00	2	Output frequenc:
3	.0-	0	Not assigned	3	.0-	0	Not assigned
4	.0-	0	Not assigned	4	.0-	0	Not assigned
5	.0-	0	Not assigned	5	.0-	0	Not assigned
6	.0-	0	Not assigned	6	.0-	0	Not assigned

Save Abort Password

© 2010 - 2011, TSJ. All Rights Reserved.

When I/O scanner of the Modbus[®] TCP protocol are modified from the webserver, input the PASSWORD. (The default password is "USER.")

Select the I/O scan parameters in "Config" column.

TOSHIBA
Leading Innovation >>>

Home Documentation...
Monitoring Network Setup Diagnostics

EtherNet/IP Scanner configuration

EtherNet/IP Scanner configuration

Assembly 102				Assembly 152			
	Config	Value	Description		Config	Value	Description
1	FA06	1	Communication ci	1	FD01	1	Inverter status
2	.0-	3	Frequency commai	2	FD00	2	Output frequenc:
3	FA07	0	Not assigned	3	.0-	0	Not assigned
4	FA50	0	Not assigned	4	.0-	0	Not assigned
5	FA51	0	Not assigned	5	.0-	0	Not assigned
6	F601	0	Not assigned	6	.0-	0	Not assigned
	ACC						
	DEC						
	UL						
	VB						
	VLV						

Save Abort Password

13.8. Administration (Main menu: Network Setup)

The "web read password" and "web write password" of the webserver can be modify on this page.

13.9. TCP/IP statistics (Main menu: Diagnostics)

You can check TCP/IP status on this page.

TOSHIBA

Leading Innovation >>>

- Diagnostics
- TCP/IP statistics
- Modbus statistics
- Ethernet IP statistics

Home Documentation...

Monitoring Network Setup

Diagnostics

Ethernet and TCP/IP statistics

TCP/IP parameters		Status	
IP Address	10-181-38-141	Link Status (right/B port)	Link down
Subnet mask	255-255-254-0	Link Status (left/A port)	100BaseTX-FD
Default gateway	10-181-38-3	Receive statistics	
IP Mode	DHCP	Frames received OK	28617
Ethernet parameters		CRC errors	0
MAC Address	00-30-11-FF-01-	Transmit statistics	
Ethernet frame format	Ethernet II	Frames transmitted OK	22730
Data rate (right/B port)	Link down	Collisions	0
Data rate (left/A port)	100 Mbps	Carrier sense errors	0
		Excessive collisions	0
		Late collisions	0

Reset counters

© 2010 - 2011, TSU. All Rights Reserved.

TOSVERT VF Series

TOSHIBA

Leading Innovation >>>

- Diagnostics
- TCP/IP statistics
- Modbus statistics
- Ethernet IP statistics

Home Documentation...

Monitoring Network Setup

Diagnostics

Modbus Messaging statistics

Inbound / Outbound statistics		IO Scanner statistics	
Opened TCP connections	1	IO scans received	0
Sent Modbus msg	22750	IO scans transmitted	0
Received Modbus msg	22750	Error messages	0
		IO scan errors	0

Reset counters

© 2010 - 2011, TSU. All Rights Reserved.

TOSVERT VF Series

TOSHIBA

Leading Innovation >>>

- Diagnostics
- TCP/IP statistics
- Modbus statistics
- Ethernet IP statistics

Home Documentation...

Monitoring Network Setup

Diagnostics

Ethernet IP statistics

Connection diagnostic		Explicit Messaging diagnostic	
Max CIP IO Connections opened	1	Class3 Msg Send Counter	0
Current CIP IO Connections	1	Class3 Msg Receive Counter	0
Max CIP Exp Connections opened	0	UCMM Msg Send Counter	1
Current CIP Exp Connections	0	UCMM Msg Receive Counter	1
CIP Connection Opening Errors	0	Bandwidth diagnostic	
CIP Connection Timeout Errors	0	Current sending Urgent prio rate (pkt/s)	0
Max EIP TCP Connections opened	1	Current reception Urgent prio rate (pkt/s)	0
Current EIP TCP Connections	1	Current sending Scheduled prio rate (pkt/s)	100
		Current reception Scheduled prio rate (pkt/s)	100
IO Messaging diagnostic		Current sending High prio rate (pkt/s)	0
IO Production Counter	36309	Current reception High prio rate (pkt/s)	0
IO Consumption Counter	36234	Current sending Low prio rate (pkt/s)	0
IO Production Send Errors Counter	0	Current reception Low prio rate (pkt/s)	0
IO Consumption Receive Errors Counter	0	Current sending Explicit rate (pkt/s)	0